

COMBINING INTRINSIC SAFETY WITH SURGE PROTECTION IN THE HYDROCARBON INDUSTRY

Class #8025

Dan McCreery
Global SPD Support
Cooper Crouse-Hinds MTL Inc
4300 Fortune Place, Suite A
Melbourne, FL USA

Synopsis:

Techniques and equipment required to provide proper intrinsic safety and surge protection when installing electronics as it relates to the Gas Industry.

Introduction

The Hydrocarbon Measurement Industry faces a rather unique combination of problems.

First, many of the areas in and around pumping, custody transfer and storage areas are classified, or hazardous, that must, according to the National Electric Code, be assessed for “explosion-proofing”. This may be in the form of intrinsic safety barriers or isolators, explosion-proof enclosures and conduits, purged enclosures or non-incendive components.

The second challenge facing the industry is the physical exposure of most of the electronic control and measuring systems, communications, and power subsystems, each with their own sensitive, high-performance microprocessors, etc., to potentially devastating lightning and electrical surges.

The goal of this discussion is to explain just how to achieve both safety and surge protection in hazardous areas using nearly identical engineering techniques.

The Hydrocarbon Measuring Environment

In referring to the “typical” compressor, custody transfer or gate station in Figure 1, it becomes readily obvious that there exist numerous electrical and electronic devices located in either Class 1, Division 1 or Division 2 Hazardous locations as defined by NEC, Articles 500-505. These pressure and temperature transmitters, flowmeters and valves, many of them “smart” microprocessor based instruments must operate safely in this environment.

Figure 1.

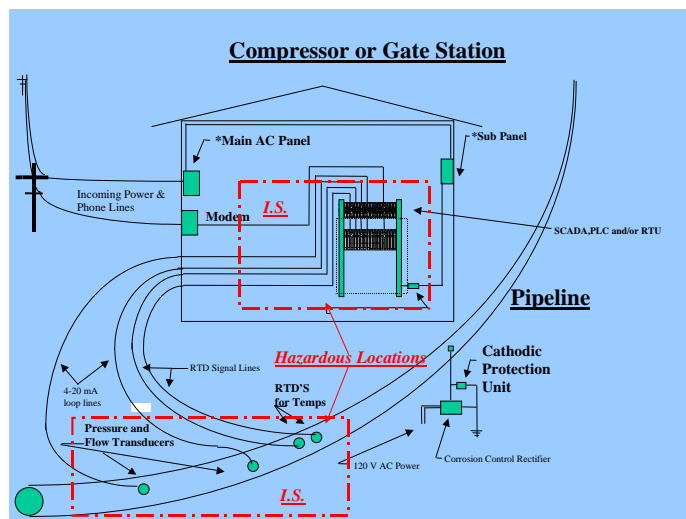

These field-mounted instruments must communicate with the PLC, SCADA, or RTU control systems located remotely in the station via wiring, normally 18AWG TSP

It is this wiring that forms a pathway for fault energies from the control system to be conducted into the hazardous location and to potentially cause ignition of the hydrocarbon there. There are approximately 18 major fires and explosions per year occurring in our processing and hydrocarbon plants in the U.S. today!

While in Europe there is only one per year!! Why? In Europe, Intrinsic Safety is the only method of “explosion-proofing” permitted in the Zone 1 or Division 1 areas. It has clearly proven to be the safest technique for explosion proofing.

WHAT IS INTRINSIC SAFETY?

Quite simply put, intrinsic safety is a system that limits the amount of energy in a hazardous location to below the amount required to cause ignition of the hydrocarbon that we are measuring. Take note that it is a “system”, not just a component. The field instrument, wiring and I.S. barrier must be “matched” in order to achieve the desired low-energy results. Please refer to the explosion triangle in Figure 2 defining the elements required to have an explosion.

Figure 2.

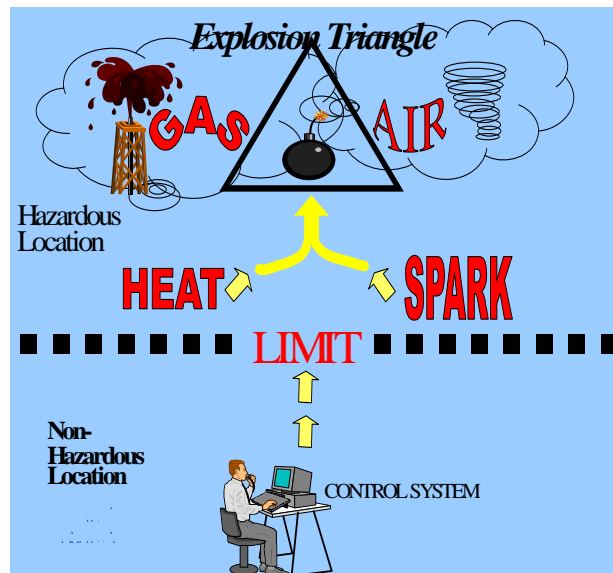

If the hazardous location is defined as the explosive triangle, then the I.S. barrier device limits the electrical energy that may transfer as either heat or spark to the combustible location.

Intrinsic Safety achieves this energy limiting goal by limiting voltage, current and stored electrical energy. What is meant by stored electrical energy?

The electronics in all field instruments have some forms of capacitors and inductors. Each one of these devices acts like a small energy storage device. When combined with the inherent inductance and capacitance naturally found in the instrument wiring itself, the total energy potentially could cause ignition of the hydrocarbon. Figure 3 defines the three basic objectives of energy limitation required by intrinsic safety.

Figure 3.

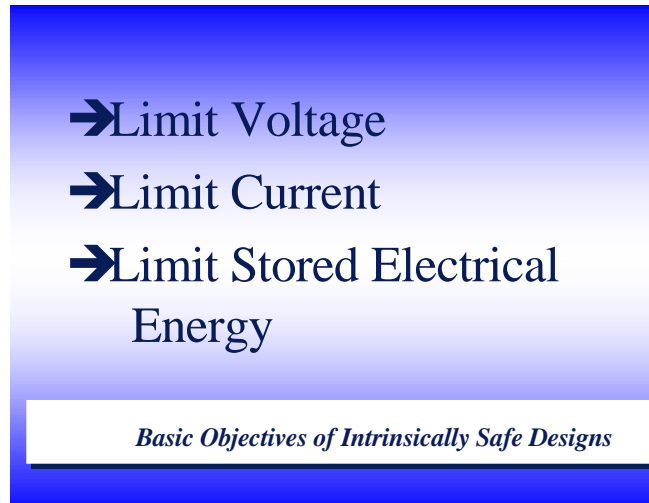

How is this limitation accomplished and how can it practically be applied to the typical 4-20mA current loop?

ENTITY PARAMETERS

Every intrinsically safe barrier or isolator, when certified, is examined and assigned values which define both the energy capable of being released from it as well as the combined unprotected energy allowed to be contained in the field instrument and wiring.

These four values are known as the “entity parameters”. They are as follows:

- Voc (open circuit voltage)
- Isc (short circuit current)
- Ca (allowed capacitance)
- La (allowed inductance)

Likewise, when a field instrument such as a transmitter is assessed for stored energy, it is assigned similar values as follows:

- Vmax (maximum safe voltage to apply)
- Imax (maximum safe current)
- Ci (inherent, unprotected capacitance)
- Li (inherent, unprotected inductance)

To safely match a field instrument to an intrinsically safe barrier or isolator, the following equation should be followed:

| <u>Barrier</u> | <u>Field Instrument</u> |
|--------------------|-------------------------|
| $V_{oc} < V_{max}$ | |
| $I_{sc} < I_{max}$ | |
| $C_a > C_i$ | |
| $L_a > L_i$ | |

If the interconnecting cabling is less than 1,000 feet, then the stored capacitance and inductance of the cable can be safely ignored. If it is over 1,000 feet, then these values must be added to the Ci and Li of the field instrument and the combination must be less than the Ca and La of the I.S. barrier or isolator.

Figure 4 illustrates the parts of an intrinsically safe system.

Figure 4.

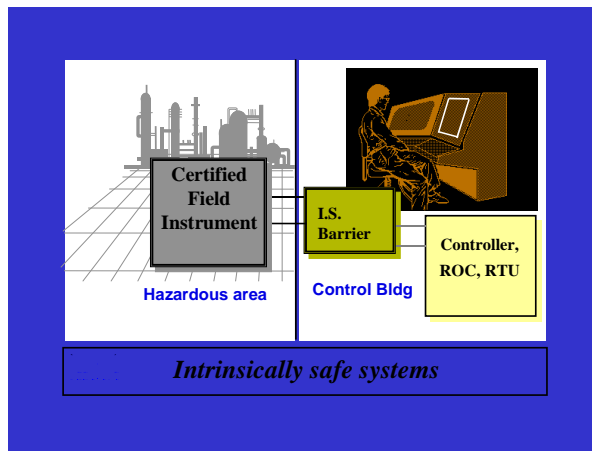

OTHER EXPLOSION-PROOF TECHNIQUES

Needless to say, intrinsic safety is not the only method of preventing explosions in hazardous areas of the hydrocarbon measurement industry. Touching on only the most commonly used:

EXPLOSION PROOFING:

Certainly the oldest method and the one most widely used in the U.S. and Canada. This method relies on precisely defined escape pathways that sufficiently cool the hot gasses resulting from an internal explosion such that they are incapable of propagating the explosion from the inside of the thick walled container or conduiting to the outside environment.

Is it safe? Of course. As long as the escape paths for the hot gasses are properly maintained, no unauthorized sealants are used to prevent the gasses from escaping, and no bolts are left out of the covers. The question goes begging though, why permit an explosion in the first place?

PURGING:

Quite common throughout the hydrocarbon industry where analyzers must be situated in hazardous locations. The three levels of purging, X, Y and Z permit installation of instrumentation not rated for the area classification.

This technique relies on forced air or inert gasses, neither of which is easily or inexpensively maintained, to dilute any residual flammable gasses from a well-defined chamber in the hazardous location. Sometimes this is the only method of explosion proofing; for instance entire control rooms on offshore platforms where the platform itself is classified hazardous.

NON-INCENDIVE:

A relative newcomer to the explosion proof family, this technique is acceptable only in Division 2 classifications. But since a relative 85% or more of our classified areas are Division 2 rather than Division 1, it has gained in popularity rapidly since its concept and introduction by Ernie Magison of Honeywell in the early 1990s. There are two levels of the Non-Incendive Technique:

1. Energy Limited Non-Incendive
2. Non-Energy Limited Non-Incendive

Briefly outlining these techniques, energy limited non-incendive is very similar to intrinsic safety in that it relies on limiting the fault energy in a Division 2 control circuit to below the level which can result in ignition of the hydrocarbon there. The primary difference in techniques is that intrinsic safety allows for a safety energy factor of 1.5 below the ignition level while non-incendive is 1.1.

Non-energy-limited-non-incendive resembles the explosion proof technique more closely in that wiring must have mechanical protection, is run in conduiting with seal-offs; field devices such as level switches, must be hermetically sealed. The advantages of this method are that 120VAC or raw 24VDC, may be run in thin walled tubing to provide power to four-wire transmitters or analyzers in Division 2.

SURGE PROTECTION IN THE HYDROCARBON MEASUREMENT INDUSTRY

WHY IS SURGE PROTECTION NECESSARY?

It is not until lightning strikes somewhere nearby that an appreciation for the tremendous power exhibited in all of Nature's fury is revealed.

Yet, the NOAA states that there are approximately 1,800 thunderstorms occurring around the earth at any given moment. And in that same moment lightning has struck somewhere in the U.S. an average of 6 times! Please refer to the Lightning Map in Figure 5 on the next page to reveal the number of strikes in a particular area while keeping in mind that each strike has as many as sixteen side flashes that are equally devastating to our instrumentation.

FIGURE 5.

Lightning Strikes in the U.S.

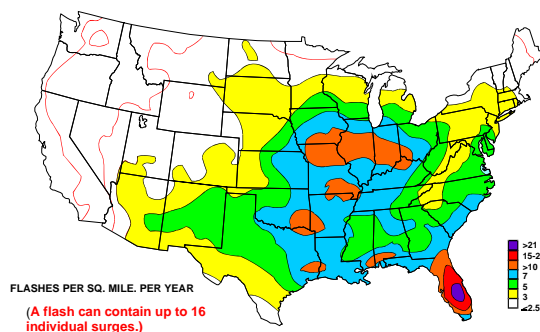

HOW DOES LIGHTNING GET INTO THE CONTROL LOOP OR POWER CIRCUIT?

It must be appreciated that the vast majority of distributed instruments in our facilities such as analyzers, temperature and pressure transmitters, current to pneumatic (I/P) valves, recorders, etc., are all connected to the Input/Output (I/O) control elements in the form of Distributed Control Systems (DCS), Programmable Logic Controllers (PLC), etc., via copper conductors.

These copper conductors form the metallic highways upon which surges may travel throughout the entire control network. Lightning may enter this highway system via several methods:

DIRECT ATTACHMENT

The most obvious method and often most damaging. A strike on the electrical cabling on the stack can destroy instruments at both ends of the cable run. Where there is significant risk of a direct strike, external structural protection based on lightning rods and grounding conductors can be of assistance.

CAPACITIVE/INDUCTIVE COUPLING

Because the "underside" of a highly charged thundercloud carries a tremendous negative potential, there is an enormous electric field that is "coupled" into the instrument/power cables at the moment of discharge. Likewise the high current (in tens to hundreds of kiloamperes) flowing down the ground paths may easily be coupled inductively into the instrument cables routed alongside.

RESISTIVE COUPLING

Easily the most common form of insertion of damaging energy into our control and monitoring circuitry. If an ideal low resistance, single point, grounding system existed in the plant, then resistive coupling would be a non-issue. Since this is rarely the case in practice because of the relative size, complexity, and disparity of ages of different parts of the plant, instrument and grounding systems tend to be spread out, sometimes over thousands of feet.

Slight differences in resistances to true power ground between different points within the grounding network result in voltage potentials ranging from several hundred volts to tens of thousands of volts depending on the amount of current induced by the surge. Please refer to Figure 6 for an illustration of how this occurs.

These potentials readily appear across the I/O and communications lines interconnecting the control network. Since instrumentation, I/O modules, etc., rarely have in excess of 1500 volts isolation, they are susceptible to damage even by modestly low level transient surges.

FIGURE 6.

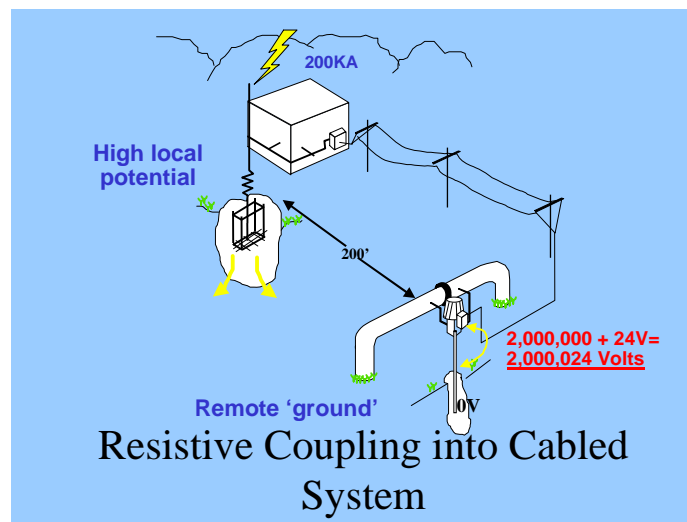

EQUIPMENT FAILURE MODES

Remarkably enough less than 5% of instrumentation and communication failures are due to “catastrophic” causes such as lightning strikes, transmission faults, brownouts, etc. The remaining 95% of failures are due to repeated “degradation” of the equipment due to transients that fall into a category between safe or normal and catastrophic operation of a microprocessor or I/C. Visualize the relative effects of destructive surges in Figure 7 as below.

Figure 7.

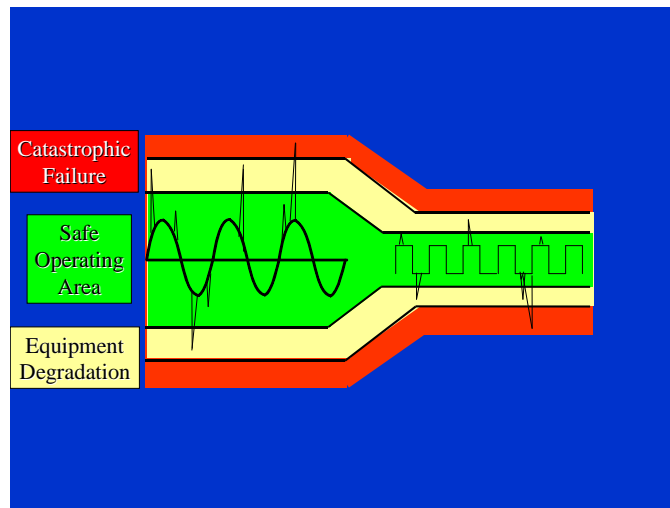

The result of repeated “attack” on solid state devices present in nearly all hydrocarbon measuring instruments by transients at the degradation level are unexplained “clear blue day” failures and significantly reduced Mean Time Between Failure (MTBF) of the equipment.

Simply put, expensive transmitters and I/O boards, which are now I.C. or microprocessor based, may only last 3-5 years rather than the 25-30 years for which they are designed!

RELATIVE SENSITIVITY OF COMPONENTS TO DAMAGE

Microprocessors are subject to weakening damage from reverse voltage/currents as little as 1 microjoule. Integrated circuits are subject to damage from as little reverse voltages as 10 microjoules. To conceptualize a microjoule, imagine standing a quarter on edge and permitting it to fall onto its side. This relatively tiny expenditure of mechanical energy has been calculated to be equivalent to approximately 20 microjoules of electrical energy, a factor of two and ten times more energy respectively than is required to damage the I/C and the microprocessor.

Please refer to the chart on Figure 8 showing the relative sensitivity of electrical and electronic components to electrical damage.

FIGURE 8.

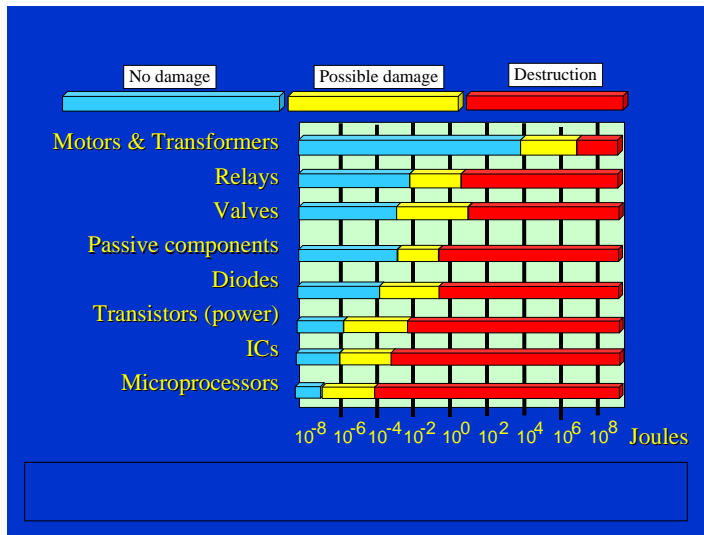

WHAT DEVICES CAN WE USE FOR SURGE PROTECTION?

Fortunately there are a number of devices that are available to protect gate stations and pump/metering sites against voltage transients and surges. The chart on Figure 9 on the following page depicts the majority of these devices and their relative capabilities with regard to protecting expensive and sensitive instrumentation. Unfortunately no single device is ideal in all aspects.

A brief review of the various devices reveals that some have high-energy capabilities but poor response times while others have a much quicker speed of response but low energy capabilities. What this means is that no single device achieves an ideal state of protection for the hydrocarbon measuring environment!

Figure 9.

| Device | Speed | Sensitivity | Energy | Stability |
|-----------|--------|-------------|--------|-----------|
| Air Gap | Fast | Poor | High | Poor |
| GDT | Fast | Good | High | Good |
| Zener | V Fast | V Good | Low | Excellent |
| Transorb | V Fast | Good | Medium | Excellent |
| Varistors | Fast | Poor | High | Poor |
| Relays | V Slow | Good | Medium | Good |
| Fuses | Slow | Fair | Medium | Good |

As a result the only practical solution is to use a combination of devices, drawing on the strengths of each, in a circuit known as a “resettable” hybrid surge protector.

An example of this would be to employ both a zener diode with extremely fast response time to the leading edge of the 8-20 microsecond typical surge pulse in combination with a gas discharge tube having very high energy capability to carry the relative bulk of the balance of the current impulse. The critical and harmful “let-through voltage” of this type of device remains in a safe zone in comparison to single component protectors that are often offered only as modicums of protection by reputable instrument manufacturers.

AC POWER PROTECTION CONSIDERATIONS

What about AC power circuits? Up to this point, the focus of this discussion has been on control instrumentation, usually 24VDC or lower circuits.

AC power must also be a consideration as it provides the primary power to all the DC circuits on site. It follows then that these same heavy copper electrical highways constitute “superhighways” for both damaging noise and surges to enter the control system.

AC circuits should be treated in a “zoned” approach beginning with the Class C3 entry, Main power distribution panel level, where massive surges from utility line lightning and grid switching can appear. A properly sized primary power protector at this point limits the externally generated let-through to a manageable level within the station.

The second zone for AC power protection is at the power distribution sub-panel. Here the ideal AC power protector is based on high reliability, oversized MOVs that not only picks up the pass through surges from the C3 level protectors but also suppresses the myriad of internally generated transients from such sources as motor switching or arc welding. These are the types of surges which by themselves are not catastrophic but are insidiously degrading to computers, communications, and expensive hydrocarbon measuring types of equipment.

The last line of defense for AC protection is at the equipment level itself. Here we are looking to suppress immediate area noise, UPS switching transients, and equipment power switching. Ideally a surge device at this level will not only protect against surge transients but will also incorporate noise filters to minimize or eliminate RFI, hum, and ringing on the AC line that are often responsible for microprocessor malfunction.

TO GROUND OR NOT TO GROUND

The topic of “Grounding” and “Bonding” have been subjects of entire studies, books, workshops, seminars unto themselves—and justifiably so. There exist more experts on this subject—just ask someone—than any other. Rather than becoming immersed in such a controversial subject, please focus on grounding specifically as it relates to surge protection devices.

There exist three primary requirements for the grounding of SPDs (Surge Protection Devices). They are in order:

DIVERT SURGE CURRENT AS SOON AS POSSIBLE.

The longer an 8 X 20 microsecond, possibly 6,000V, surge transient is permitted to reside in the control system, the more potential for damage exists. Hence it is imperative to detect and divert that pulse to a safe ground plane just as quickly as possible.

USE DEDICATED LOW IMPEDANCE CONNECTION.

This bond to the ground plane cannot be overemphasized. Ideally the resistance to the ground plane would be less than 0.1 ohms. I recently visited a plant experiencing severe lightning/surge problems at Cape Fear, NC, where the measured resistance to the ground plane was found to be 18 ohms. A direct strike of 200,000 amperes to a lightning rod on their plant could easily produce a voltage across the entire building, by Ohm's Law: $I \times R = E$ or $200,000A \times 18R = 3,600,000V$. On recommendation, the site reduced the resistance to the ground plane to 0.1 ohms, and the same lightning surge will produce a 20,000 volt pulse that is much easier to manage.

ENSURE THAT ALL SYSTEMS ARE CONNECTED TO GROUND, ONCE!

Look at the accompanying AC Distribution diagram on Figure 10 and appreciate the fact that all the subsystems in the plant, instrumentation, communication, computers and control, AC power, are connected to a single point ground system. This is known as “star point” grounding. Properly done, each subsystem ground is kept as short as reasonably possible and is connected to the star point at only one point. Multiple paths to the ground plane from a subsystem inherently have different resistances. Different resistances to ground produce, again by Ohm’s Law, different voltage potentials to the subsystem that result in transient surge damage to that system!

Figure 10.

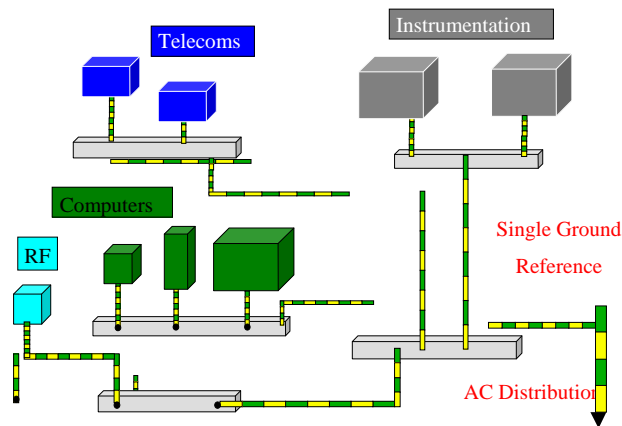

PULLING I.S. AND SURGE TOGETHER IN THE PLANT OR GATE STATION

The primary elements of any gate station or plant facility consists of remote instrumentation located on vulnerable pipelines connected to control elements in buildings. Instruments-wiring-controllers. Look at these elements shown in Figure 11 and it becomes fairly obvious that a common solution employing nearly identical hybrid diode techniques and grounding makes absolute sense.

FIGURE 11.

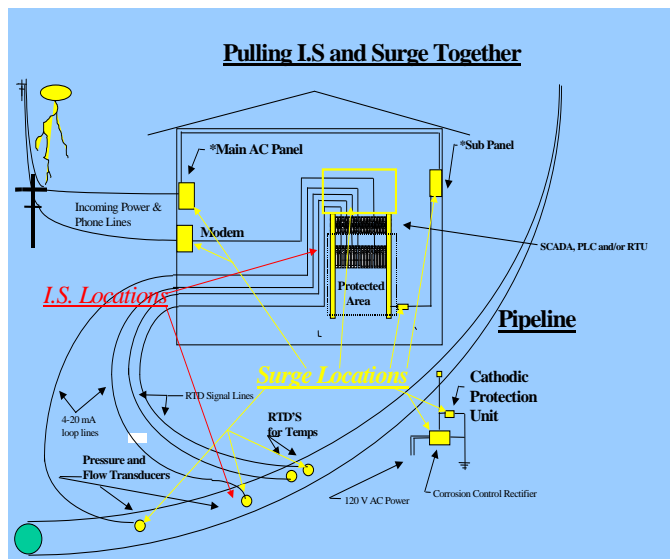

Closer inspection of Figure 11 reveals that some of the very same areas and instruments vulnerable to lightning and surge damage are the same areas requiring intrinsically safe barrier protection.

How does this look schematically? Figure 12 shows the typical 4-20mA transmitter current loop at, say, a gate station. It could just as well be a pressure, temperature or flow transmitter connected to a PLC input module.

Figure 12.

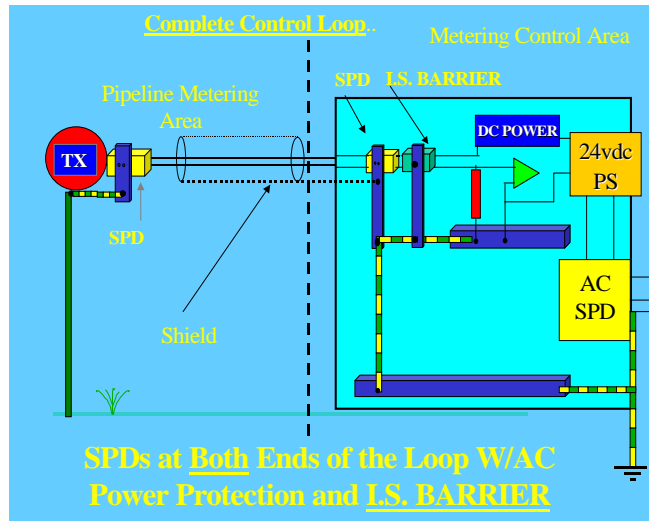

Now all the elements of the control system beginning with the field transmitter, the wiring, the intrinsically safe barriers, the PLC I/O, in addition to the DC and AC power supplies are continuously shielded from explosion or the ravages of lightning and surge.

SUMMARY

The common technology of lightning/surge protection and intrinsic safety provides the safest proven technology for protecting both personnel and equipment in the hydrocarbon measurement industry.

It is a system concept; not a piecemeal one. Combining the two similar technologies protects equipment located at both ends of the control loop and not only allows equipment to live to its full MTBF (Mean Time Between Failure) but reduces maintenance costs and downtime.

REFERENCES

1. Authored by: Donald R. Long, Applications Engineering Manager, MTL Inc.
2. N.O.A.A. (National Oceanic and Atmospheric Administration), "Lightning Map", www.ncdc.noaa.gov.
3. Telematic Limited, A member of the MTL Instruments Group, plc., TAN (Technical Application Note) #1003/1, June, 1996, "How Lightning Interacts with electronic systems".
4. Measurement Technology Limited, A member of The MTL Instruments Group, plc. AN9003-7 (Application Note), November, 1999, "A User's Guide to Intrinsic Safety".