

**FLUKE®**

**789**  
ProcessMeter

**Calibration Manual**

## **LIMITED WARRANTY AND LIMITATION OF LIABILITY**

Each Fluke product is warranted to be free from defects in material and workmanship under normal use and service. The warranty period is three years and begins on the date of shipment. Parts, product repairs, and services are warranted for 90 days. This warranty extends only to the original buyer or end-user customer of a Fluke authorized reseller, and does not apply to fuses, disposable batteries, or to any product which, in Fluke's opinion, has been misused, altered, neglected, contaminated, or damaged by accident or abnormal conditions of operation or handling. Fluke warrants that software will operate substantially in accordance with its functional specifications for 90 days and that it has been properly recorded on non-defective media. Fluke does not warrant that software will be error free or operate without interruption.

Fluke authorized resellers shall extend this warranty on new and unused products to end-user customers only but have no authority to extend a greater or different warranty on behalf of Fluke. Warranty support is available only if product is purchased through a Fluke authorized sales outlet or Buyer has paid the applicable international price. Fluke reserves the right to invoice Buyer for importation costs of repair/replacement parts when product purchased in one country is submitted for repair in another country.

Fluke's warranty obligation is limited, at Fluke's option, to refund of the purchase price, free of charge repair, or replacement of a defective product which is returned to a Fluke authorized service center within the warranty period.

To obtain warranty service, contact your nearest Fluke authorized service center to obtain return authorization information, then send the product to that service center, with a description of the difficulty, postage and insurance prepaid (FOB Destination). Fluke assumes no risk for damage in transit. Following warranty repair, the product will be returned to Buyer, transportation prepaid (FOB Destination). If Fluke determines that failure was caused by neglect, misuse, contamination, alteration, accident, or abnormal condition of operation or handling, including overvoltage failures caused by use outside the product's specified rating, or normal wear and tear of mechanical components, Fluke will provide an estimate of repair costs and obtain authorization before commencing the work. Following repair, the product will be returned to the Buyer transportation prepaid and the Buyer will be billed for the repair and return transportation charges (FOB Shipping Point).

**THIS WARRANTY IS BUYER'S SOLE AND EXCLUSIVE REMEDY AND IS IN LIEU OF ALL OTHER WARRANTIES, EXPRESS OR IMPLIED, INCLUDING BUT NOT LIMITED TO ANY IMPLIED WARRANTY OF MERCHANTABILITY OR FITNESS FOR A PARTICULAR PURPOSE. FLUKE SHALL NOT BE LIABLE FOR ANY SPECIAL, INDIRECT, INCIDENTAL OR CONSEQUENTIAL DAMAGES OR LOSSES, INCLUDING LOSS OF DATA, ARISING FROM ANY CAUSE OR THEORY.**

Since some countries or states do not allow limitation of the term of an implied warranty, or exclusion or limitation of incidental or consequential damages, the limitations and exclusions of this warranty may not apply to every buyer. If any provision of this Warranty is held invalid or unenforceable by a court or other decision-maker of competent jurisdiction, such holding will not affect the validity or enforceability of any other provision.

Fluke Corporation  
P.O. Box 9090  
Everett, WA 98206-9090  
U.S.A.

Fluke Europe B.V.  
P.O. Box 1186  
5602 BD Eindhoven  
The Netherlands

# Table of Contents

| Title                                               | Page |
|-----------------------------------------------------|------|
| Introduction.....                                   | 1    |
| Contacting Fluke .....                              | 1    |
| Read First -Safety Information .....                | 2    |
| Warnings and Cautions.....                          | 2    |
| Symbols .....                                       | 3    |
| Specifications.....                                 | 4    |
| General Specifications .....                        | 7    |
| Required Equipment .....                            | 7    |
| Basic Maintenance .....                             | 8    |
| Cleaning the ProcessMeter .....                     | 8    |
| Replacing the Batteries .....                       | 8    |
| Battery Life.....                                   | 9    |
| Checking and Replacing the Fuses.....               | 10   |
| Calibration Verification .....                      | 11   |
| Preparing to Perform Calibration Verification ..... | 11   |
| Loop Power .....                                    | 12   |
| Current Sourcing.....                               | 13   |
| Current Measurement .....                           | 14   |
| Checking the Diode Test Function .....              | 15   |
| Checking the Continuity Test Function.....          | 17   |
| Resistance Measurement Test .....                   | 18   |
| DC Millivolts Measurement Test .....                | 20   |
| DC Volts Measurement Tests.....                     | 21   |
| AC Volts Measurement Test .....                     | 22   |
| Frequency Measurement Test.....                     | 23   |
| Calibration Adjustment.....                         | 24   |
| Preparing for Calibration Adjustment .....          | 24   |
| AC Voltage Adjustment .....                         | 25   |
| Frequency Adjustment.....                           | 26   |
| DC Voltage Adjustment .....                         | 27   |
| DC Millivolts Adjustment .....                      | 28   |
| Ohms Adjustment.....                                | 28   |
| Diode Adjustment.....                               | 29   |
| Milliamps DC Adjustment.....                        | 29   |
| Amps DC Adjustment .....                            | 30   |
| Amps AC Adjustment .....                            | 30   |
| Milliamps Output Adjustment .....                   | 30   |
| Replacement Parts and Accessories.....              | 31   |



# ***List of Tables***

| <b>Table</b> | <b>Title</b>                                                       | <b>Page</b> |
|--------------|--------------------------------------------------------------------|-------------|
| 1.           | Symbols.....                                                       | 3           |
| 2.           | Required Equipment and Software.....                               | 8           |
| 3.           | Typical Alkaline Battery Life .....                                | 9           |
| 4.           | Current Sourcing Test .....                                        | 13          |
| 5.           | DC mA Test .....                                                   | 15          |
| 6.           | DC Amp Test .....                                                  | 15          |
| 7.           | AC Amp Test .....                                                  | 15          |
| 8.           | Resistance Measurement Test Using a 5500A or 5520A Calibrator..... | 19          |
| 9.           | DC mV Test .....                                                   | 20          |
| 10.          | DC Volts Test.....                                                 | 22          |
| 11.          | AC Volts Test.....                                                 | 22          |
| 12.          | Frequency Measurement Test .....                                   | 23          |



# *List of Figures*

| <b>Figure</b> | <b>Title</b>                                         | <b>Page</b> |
|---------------|------------------------------------------------------|-------------|
| 1.            | Replacing the Batteries and Fuses.....               | 9           |
| 2.            | Verifying Loop Power.....                            | 12          |
| 3.            | Current Sourcing Connections Using the HP 3458A..... | 13          |
| 4.            | Current Measurement Test Connections.....            | 14          |
| 5.            | Diode Test Connections.....                          | 16          |
| 6.            | Continuity Test Connections.....                     | 17          |
| 7.            | Resistance Measurement Test Connections.....         | 18          |
| 8.            | DC mV Measurement Test Connections.....              | 20          |
| 9.            | AC/DC Voltage Measurement Test Connections.....      | 21          |
| 10.           | Frequency Measurement Test Connections.....          | 23          |
| 11.           | Calibration Button Access.....                       | 26          |
| 12.           | Replacement Parts.....                               | 31          |





# 789 ProcessMeter

## Introduction

### ⚠⚠ Warning

The information provided in this manual is for the use of qualified personnel only. Do not perform the calibration verification tests or calibration procedures described in this manual unless you are qualified to do so.

### ⚠ Caution

The 789 ProcessMeter™ contains parts that can be damaged by static discharge. No procedure in this document requires the case to be opened. If you do so, follow the standard practices for handling static sensitive devices.

The *Calibration Manual* for the 789 ProcessMeter (hereafter, also referred to as “the ProcessMeter” or “the UUT”) provides the following information:

- Precautions and Safety information
- Specifications
- Basic maintenance (cleaning, replacing the batteries and fuses)
- Calibration verification test procedures
- Calibration adjustment procedures
- Accessories and replaceable parts

For complete operating instructions, refer to the *789 ProcessMeter Users Manual* (on the CD-ROM provided).

## Contacting Fluke

To contact Fluke, call:

USA : 1-888-99-FLUKE (1-888-993-5853)  
Europe: +31 402-678-200  
Singapore: +65-738-5655

Canada: 1-800-36-FLUKE (1-800-363-5853)  
Japan: +81-3-3434-0181  
Anywhere in the world: +1-425-446-5500

Address correspondence to:

Fluke Corporation  
P.O. Box 9090,  
Everett, WA 98206-9090  
USA

Fluke Europe B.V.  
P.O. Box 1186,  
5602 BD Eindhoven  
The Netherlands

Or visit us on the World Wide Web: [www.fluke.com](http://www.fluke.com)

## Read First -Safety Information

### Warnings and Cautions

In this manual, a **Warning** identifies conditions and actions that pose hazard(s) to the user; a **Caution** identifies conditions and actions that may damage the ProcessMeter or the test instruments.

#### Warning

To avoid possible electric shock or personal injury:

- Do not use the ProcessMeter if it looks damaged.
- Examine the ProcessMeter before use. Look for cracks in the case, missing plastic, or damaged insulation around the connectors.
- Inspect the test leads for damaged insulation or exposed metal. Check for test lead continuity. Replace damaged test leads.
- Do not use the ProcessMeter if it operates abnormally. Protection provided by the ProcessMeter may be impaired. When in doubt, have the ProcessMeter serviced.
- Do not apply more than the rated voltage as marked on the ProcessMeter between terminals or between any terminal and earth ground.
- When using probes, keep fingers behind the finger guards on the probes.
- Use caution when working above 30 V ac rms, 42 V ac peak, or 60 V dc. Such voltages pose a shock hazard.
- Connect the common lead (COM) before connecting the live test lead. When disconnecting test leads, disconnect the live test lead first.
- Remove test leads from the ProcessMeter before opening the battery compartment door.
- Do not operate the ProcessMeter around explosive gas, vapor, or dust.
- During normal operation, use only type AA batteries, properly installed in the ProcessMeter case, to power the ProcessMeter.
- Make sure the battery compartment door is closed and latched before you operate the ProcessMeter.
- During calibration adjustment, use only specified calibration equipment listed in Table 2.
- When servicing the ProcessMeter, use only specified replacement parts.
- Before measuring current, check the ProcessMeter's fuses, see "Checking and Replacing the Fuses".
- To avoid false readings, which can lead to possible electric shock or personal injury, replace the batteries as soon as the low battery indicator () appears.

**⚠ Caution**













To avoid possible damage to the ProcessMeter or the test equipment:

- **Disconnect the power and discharge all high voltage capacitors before testing resistance, diodes, or continuity.**
- **Use the proper terminals, switch setting, and range for the measurement or sourcing applications.**

## Symbols

Symbols used on the ProcessMeter and in this calibration manual are explained in Table 1.

Table 1. Symbols

| Symbol                                                                              | Meaning                                                                                                                                                                                                                                                                                                        | Symbol                                                                              | Meaning                                                        |
|-------------------------------------------------------------------------------------|----------------------------------------------------------------------------------------------------------------------------------------------------------------------------------------------------------------------------------------------------------------------------------------------------------------|-------------------------------------------------------------------------------------|----------------------------------------------------------------|
|    | Alternating current                                                                                                                                                                                                                                                                                            |    | Earth ground                                                   |
|    | Direct current                                                                                                                                                                                                                                                                                                 |    | Fuse                                                           |
|    | Alternating or direct current                                                                                                                                                                                                                                                                                  |    | Conforms to European Union directives                          |
|    | Risk of danger. Important information. See manual.                                                                                                                                                                                                                                                             |    | Conforms to relevant Canadian Standards Association directives |
|  | Battery                                                                                                                                                                                                                                                                                                        |  | Double insulated                                               |
|  | Meets Underwriters' Laboratories safety requirements                                                                                                                                                                                                                                                           |  | Inspected and licensed by TÜV Product Services                 |
| CAT III                                                                             | Overvoltage (Installation) Category III, Pollution Degree 2 per EN61010 refers to the level of Impulse Withstand Voltage protection provided. Typical locations include: mains, wall outlets, main distribution levels connected closer to the supply system but less than the primary supply system (CAT IV). |  | Conforms to relevant Australian standards                      |

## Specifications

All specifications apply from +18 °C to +28 °C unless stated otherwise.

All specifications assume a 5-minute warm-up period.

The standard specification interval is 1 year.

### Note

“Counts” refers to the number of increments or decrements of the least significant digit.

### DC Volts Measurement

| Range (V dc)                                                                                                                                                                                           | Resolution | Accuracy, ±(% of Reading + Counts) |
|--------------------------------------------------------------------------------------------------------------------------------------------------------------------------------------------------------|------------|------------------------------------|
| 4.000                                                                                                                                                                                                  | 0.001 V    | 0.1 % + 1                          |
| 40.00                                                                                                                                                                                                  | 0.01 V     | 0.1 % + 1                          |
| 400.0                                                                                                                                                                                                  | 0.1 V      | 0.1 % + 1                          |
| 1000                                                                                                                                                                                                   | 1 V        | 0.1 % + 1                          |
| Input impedance: 10 MΩ (nominal), < 100 pF<br>Normal mode rejection ratio: > 60 dB at 50 Hz or 60 Hz<br>Common mode rejection ratio: > 120 dB at dc, 50 Hz, or 60 Hz<br>Overvoltage protection: 1000 V |            |                                    |

### DC Millivolts Measurement

| Range (mV dc) | Resolution | Accuracy, ±(% of Reading + Counts) |
|---------------|------------|------------------------------------|
| 400.0         | 0.1 mV     | 0.1 % + 2                          |

### AC Volts Measurement

| Range (ac)                                                                                                                                                                                                                                                                                                                                  | Resolution | Accuracy, ±(% of Reading + Counts) |                 |                  |
|---------------------------------------------------------------------------------------------------------------------------------------------------------------------------------------------------------------------------------------------------------------------------------------------------------------------------------------------|------------|------------------------------------|-----------------|------------------|
|                                                                                                                                                                                                                                                                                                                                             |            | 50 Hz to 60 Hz                     | 45 Hz to 200 Hz | 200 Hz to 500 Hz |
| 400.0 mV                                                                                                                                                                                                                                                                                                                                    | 0.1 mV     | 0.7 % + 4                          | 1.2 % + 4       | 7.0 % + 4        |
| 4.000 V                                                                                                                                                                                                                                                                                                                                     | 0.001 V    | 0.7 % + 2                          | 1.2 % + 4       | 7.0 % + 4        |
| 40.00 V                                                                                                                                                                                                                                                                                                                                     | 0.01 V     | 0.7 % + 2                          | 1.2 % + 4       | 7.0 % + 4        |
| 400.0 V                                                                                                                                                                                                                                                                                                                                     | 0.1 V      | 0.7 % + 2                          | 1.2 % + 4       | 7.0 % + 4        |
| 1000 V                                                                                                                                                                                                                                                                                                                                      | 1 V        | 0.7 % + 2                          | 1.2 % + 4       | 7.0 % + 4        |
| Specifications are valid from 5 % to 100 % of amplitude range.<br>AC conversion: true rms<br>Maximum crest factor: 3 (between 50 and 60 Hz)<br>For non-sinusoidal waveforms, add ±(2 % reading + 2 % f.s.) typical<br>Input impedance: 10 MΩ (nominal), < 100 pF, ac-coupled<br>Common mode rejection ratio: > 60 dB at dc, 50 Hz, or 60 Hz |            |                                    |                 |                  |

### AC Current Measurement

| Range<br>45 Hz to 2 kHz                                                                                                                                                                                                                                                                                                         | Resolution | Accuracy,<br>±(% of Reading + Counts) | Typical Burden<br>Voltage |
|---------------------------------------------------------------------------------------------------------------------------------------------------------------------------------------------------------------------------------------------------------------------------------------------------------------------------------|------------|---------------------------------------|---------------------------|
| 1.000 A (Note)                                                                                                                                                                                                                                                                                                                  | 0.001 A    | 1 % + 2                               | 1.5 V/A                   |
| <i>Note: 440 mA continuous, 1 A 30 seconds maximum</i>                                                                                                                                                                                                                                                                          |            |                                       |                           |
| <i>Specifications are valid from 5 % to 100 % of amplitude range.<br/>           AC conversion: true rms<br/>           Maximum crest factor: 3 (between 50 and 60 Hz)<br/>           For non-sinusoidal waveforms, add ±( 2 % reading + 2 % f.s.) typical<br/>           Overload protection 440 mA, 1000 V fast-blow fuse</i> |            |                                       |                           |

### DC Current Measurement

| Range                                                     | Resolution | Accuracy<br>±(% of Reading + Counts) | Typical Burden<br>Voltage |
|-----------------------------------------------------------|------------|--------------------------------------|---------------------------|
| 30.000 mA                                                 | 0.001 mA   | 0.05 % + 2                           | 14 mV/mA                  |
| 1.000 A (Note)                                            | 0.001 A    | 0.2 % + 2                            | 1.5 V/A                   |
| <i>Note: 440 mA continuous, 1 A 30 seconds maximum</i>    |            |                                      |                           |
| <i>Overload protection: 440 mA, 1000 V fast-blow fuse</i> |            |                                      |                           |

### Ohms Measurement

| Range                                                                              | Resolution | Measurement Current | Accuracy<br>±(% of Reading + Counts) |
|------------------------------------------------------------------------------------|------------|---------------------|--------------------------------------|
| 400.0 Ω                                                                            | 0.1 Ω      | 220 μA              | 0.2 % + 2                            |
| 4.000 kΩ                                                                           | 0.001 kΩ   | 60 μA               | 0.2 % + 1                            |
| 40.00 kΩ                                                                           | 0.01 kΩ    | 6.0 μA              | 0.2 % + 1                            |
| 400.0 kΩ                                                                           | 0.1 kΩ     | 600 nA              | 0.2 % + 1                            |
| 4.000 MΩ                                                                           | 0.001 MΩ   | 220 nA              | 0.35 % + 3                           |
| 40.00 MΩ                                                                           | 0.01 MΩ    | 22 nA               | 2.5 % + 3                            |
| <i>Overload protection: 1000 V<br/>           Open circuit voltage: &lt; 3.9 V</i> |            |                     |                                      |

### Frequency Counter Accuracy

| Range                                               | Resolution | Accuracy<br>±(% of Reading + Counts) |
|-----------------------------------------------------|------------|--------------------------------------|
| 199.99 Hz                                           | 0.01 Hz    | 0.005 % + 1                          |
| 1999.9 Hz                                           | 0.1 Hz     | 0.005 % + 1                          |
| 19.999 kHz                                          | 0.001 kHz  | 0.005 % + 1                          |
| <i>Display updates 3 times/second at &gt; 10 Hz</i> |            |                                      |

**Frequency Counter Sensitivity**

| Input Range | Minimum Sensitivity (rms Sinewave)<br>5 Hz to 5 kHz* |                                                     |
|-------------|------------------------------------------------------|-----------------------------------------------------|
|             | AC                                                   | DC<br>(approximate trigger level 5 % of full scale) |
| 400 mV      | 150 mV (50 Hz to 5 kHz)                              | 150 mV                                              |
| 4 V         | 1 V                                                  | 1 V                                                 |
| 40 V        | 4 V                                                  | 4 V                                                 |
| 400 V       | 40 V                                                 | 40 V                                                |
| 1000 V      | 400 V                                                | 400 V                                               |

\*Usable 0.5 Hz to 20 kHz with reduced sensitivity.  
10<sup>6</sup> V/Hz max

**Diode Test and Continuity Test**

**Diode test indication:** Displays voltage drop across device, 2.0 V full scale. Nominal test current 0.2 mA at 0.6 V. Accuracy  $\pm(2\% + 1 \text{ count})$ .

**Continuity test indication:** Continuous audible tone for test resistance  $< 100 \Omega$

**Open circuit voltage:**  $< 2.9 \text{ V}$

**Short circuit current:** 220  $\mu\text{A}$  typical

**Overload protection:** 1000 V rms

**Loop Power Supply**

**Loop Power Supply:** Minimum 24 V@ 24 mA into 1200  $\Omega$  load

**DC Current Output**

**Source mode:**

**Span:** 0 mA or 4 mA to 20 mA, with overrange to 24 mA

**Accuracy:** 0.05 % of span<sup>1</sup> (span: 0 to 20 mA)

**Compliance voltage:** 28 V with battery voltage  $> \sim 4.5 \text{ V}$

<sup>1</sup>0.1 x specified accuracy per  $^{\circ}\text{C}$  for temperatures  $< 18 \text{ }^{\circ}\text{C}$  or  $> 28 \text{ }^{\circ}\text{C}$

**Simulate Mode:**

**Span:** 0 mA or 4 mA to 20 mA, with overrange to 24 mA

**Accuracy:** 0.05 % of span<sup>1</sup> (span: 0 to 20 mA)

**Loop voltage:** 24 V nominal, 48 V maximum, 15 V minimum

**Compliance voltage:** 21 V for 24 V supply

**Burden voltage:**  $< 3 \text{ V}$

<sup>1</sup>0.1 x specified accuracy per  $^{\circ}\text{C}$  for temperatures  $< 18 \text{ }^{\circ}\text{C}$  or  $> 28 \text{ }^{\circ}\text{C}$

## General Specifications

**Maximum voltage applied between any jack and earth ground:** 1000 V

**Storage temperature:** -40 °C to 60 °C

**Operating temperature:** -20 °C to 55 °C

**Operating altitude:** 2000 meters maximum

**Temperature coefficient:** 0.05 x specified accuracy per °C for temperatures < 18 °C or > 28 °C

**Accuracy adds for use in RF Fields:** In an RF field of 3 V/m, change the accuracy specifications as follows:

For AC Volts Measurement, add 0.25 % of range

For DC Current Measurement, 30.000 mA range, add 0.14 % of range

For DC Current Output, add 0.32 % of span





Accuracy for all ProcessMeter functions is not specified in RF fields > 3 V/m.

**Relative humidity:** 95 % up to 30 °C, 75 % up to 40 °C, 45 % up to 50 °C, and 35 % up to 55 °C

**Vibration:** Random 2 g, 5 to 500 Hz

**Shock:** 1 meter drop test

**Safety:** Complies with EN61010, ANSI/ISA S82.01-1994 and CAN/CSA C22.2 No. 1010.1-92 Overvoltage Category III.

**Certifications:**  ,  ,  , 

**Power requirements:** Four AA batteries (alkaline recommended)

**Size:** 10.0 cm X 20.3 cm X 5.0 cm (3.94 in X 8.00 in X 1.97 in)

**Weight:** 610 g (1.6 lbs)

## Required Equipment

Equipment and software required to perform the procedures in this manual are identified in Table 2.

If the recommended equipment model is not available, in some cases other equipment can be substituted as long as it meets the specifications indicated.

### Warning

**To avoid safety hazards and equipment damage during the calibration procedure, use the specified calibration equipment listed in Table 2. Using unspecified equipment can jeopardize the calibration verification test and pose safety hazards.**

#### Note

*Unless otherwise indicated, all connection diagrams for the calibration verification tests in this manual showing a calibrator or digital multimeter use a Fluke 5500A calibrator or Agilent 3458A.*

*If you are using a different calibrator or DMM, make the connections appropriate for that instrument.*

Table 2. Required Equipment and Software

| Equipment                                           | Minimum Specifications                                                                      | Recommended Model                                            |
|-----------------------------------------------------|---------------------------------------------------------------------------------------------|--------------------------------------------------------------|
| Calibration Source                                  | No Substitute                                                                               | Fluke Model 5500A                                            |
| Digital Process Meter or Digital Process Calibrator | No Substitute                                                                               | Fluke 787 ProcessMeter<br>741,743, or 744 Process Calibrator |
| Digital Multimeter                                  | No Substitute                                                                               | Agilent 3458A                                                |
| Test Leads, low leakage, RG-58/U type               | Leakage resistance > than $1.0 \times 10^{13}$ $\Omega$ at 45 °C and 75 % relative humidity | Fluke 5440A-7002 Low Thermal Test Leads                      |

## Basic Maintenance

### Cleaning the ProcessMeter

#### **⚠ ⚠ Warning**

To avoid electrical shock or damage, never allow water inside the case of the ProcessMeter.

If the ProcessMeter requires cleaning, wipe it down with a cloth that is lightly dampened with water or a mild detergent.

#### **⚠ Caution**

Do not use aromatic hydrocarbons, chlorinated solvents, or methanol-based fluids when wiping down the ProcessMeter. To avoid damaging the case, never apply solvents to the case of the ProcessMeter.

### Replacing the Batteries

#### **⚠ ⚠ Warning**

To avoid electrical shock:

- Remove test leads from the ProcessMeter before opening the battery compartment door.
- Close and latch the battery compartment door before using the ProcessMeter.

Replace the batteries as follows. Refer to Figure 1. Use four AA alkaline batteries.

1. Remove the test leads and turn the ProcessMeter OFF.
2. With a standard blade hand screwdriver, turn each battery compartment door screw counterclockwise so that the slot is parallel with the screw picture molded into the case.
3. Lift off the battery compartment door.
4. Remove the ProcessMeter's batteries.
5. Replace with four new AA alkaline batteries.
6. Reinstall the battery compartment door and tighten screws.



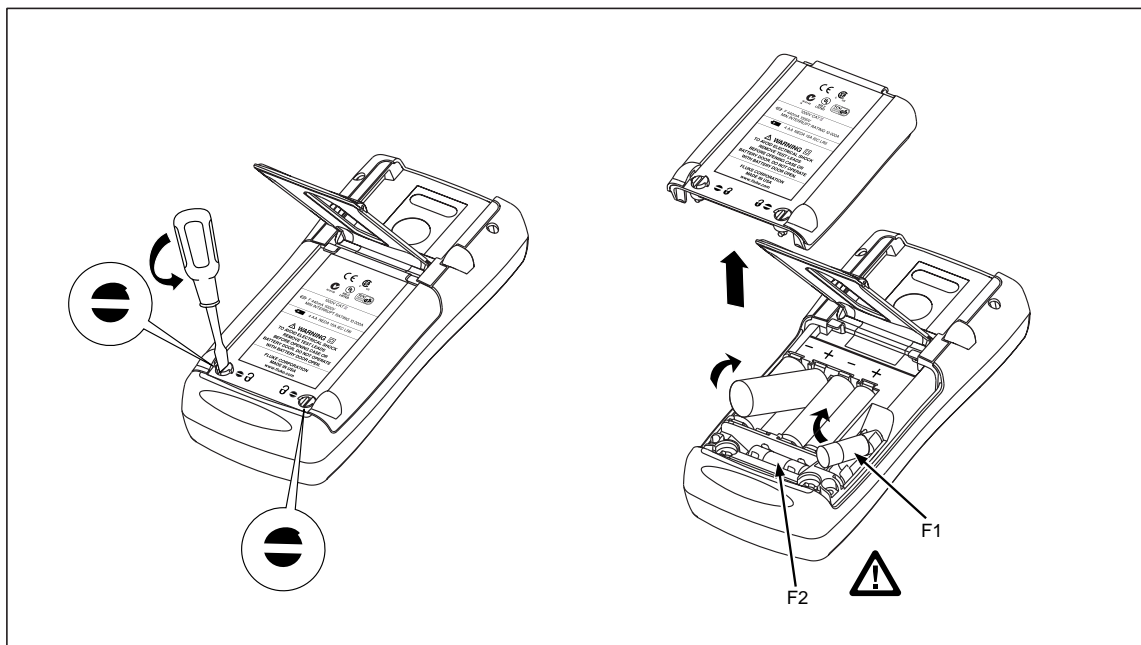

Figure 1. Replacing the Batteries and Fuses

anw037.eps

## Battery Life

### ⚠ ⚠ Warning

To avoid false readings, which can lead to possible electric shock or personal injury, replace the batteries as soon as the low battery indicator (🔋) appears.

The ProcessMeter is powered by four AA alkaline batteries.

Table 3 shows typical alkaline battery life. To preserve battery life:

- Use current simulation instead of sourcing when possible.
- Avoid using the backlight.
- Do not disable the automatic power-off feature.
- Turn the ProcessMeter off when not in use.

Table 3. Typical Alkaline Battery Life

| ProcessMeter Operation           | Hours |
|----------------------------------|-------|
| Measuring any parameter          | 140   |
| Simulating Current               | 140   |
| Sourcing 12 mA into 500 $\Omega$ | 10    |

## Checking and Replacing the Fuses

### **⚠ ⚠ Warning**

**To avoid personal injury or damage to the ProcessMeter, use only the specified replacement fuse, 440 mA 1000 V fast-blow, Fluke PN 943121.**

Both current input jacks are fused with separate 440 mA fuses. To determine if a fuse is blown:

1. Turn the rotary function switch to  $\frac{\approx}{\text{mA}}$ .
2. Plug the black test lead into COM, and the red test lead into the  $\text{A}\approx$  input.
3. Using an ohmmeter, check the resistance between the ProcessMeter test leads. If the resistance is about  $1\ \Omega$ , the fuse is good. An open reading means that fuse F1 is blown.
4. Move red test lead to  $\text{mA}\approx$ .
5. Using an ohmmeter, check the resistance between the ProcessMeter test leads. If the resistance is about  $14\ \Omega$ , the fuse is good. An open means that fuse F2 is blown.

If a fuse is blown, replace it as follows. Refer to Figure 1 as necessary:

1. Remove the test leads from the ProcessMeter and turn the ProcessMeter OFF.
2. With a standard blade hand screwdriver, turn each battery compartment door screw counterclockwise so that the slot is parallel with the screw picture molded into the case.
3. Remove either fuse by gently prying one end loose, then sliding the fuse out of its bracket.
4. Replace the blown fuse(s).
5. Replace the battery compartment door. Secure the door by turning the screws one-quarter turn clockwise.

## Calibration Verification

### ⚠ ⚠ Warning

**Some of the calibration verification tests involve the use of high voltages and should be performed by qualified personnel only.**

**To avoid electrical shock, always place the calibrator in the Standby (STBY) mode between tests and before handling the test connections or test cables.**

Calibration verification tests confirm the complete functionality of the ProcessMeter and check the accuracy of each ProcessMeter function against its specifications. If the ProcessMeter fails any calibration verification test, it needs calibration adjustment or repair.

The ProcessMeter's performance and accuracy are specified for one year after calibration at operating temperatures of +18 °C to +28 °C (64 °F to 82 °F), in relative humidity to 90 %. The specifications assume the ProcessMeter has been warmed up for 5 minutes before use.

To perform the calibration verification tests, it is not necessary to open the case; no adjustments are necessary. Merely make the required connections, source the designated values, and determine if the reading on the ProcessMeter or the multimeter falls within the acceptable range indicated.

These calibration verification test procedures assume that the person performing the tests has read the *789 Users Manual*, knows how to select functions and ranges on the ProcessMeter, and knows how to operate the required equipment.

#### Note

*Calibration verification tests for the ProcessMeter can be performed manually, or they can be computer-automated (using Fluke's MET/CAL<sup>®</sup> Calibration Software). This document provides the procedures necessary to perform the calibration verification test manually.*

## Preparing to Perform Calibration Verification

#### Note

*Throughout the calibration verification tests, "UUT" (unit under test) refers to the ProcessMeter; the word "multimeter" is reserved for the digital multimeter identified in the required equipment listed in Table 2.*

*Unless otherwise indicated, all connection diagrams for the calibration verification tests in this manual showing a calibrator or digital multimeter use a Fluke 5500A calibrator or HP 3458A.*

*If using a different calibrator or DMM make the connections appropriate for your instrument.*

To prepare the UUT for the calibration verification tests:

1. Make sure that the required equipment is available (see Table 2).
2. Make sure that the fuses in the UUT are intact. See "Checking and Replacing a Fuse" earlier in this manual.
3. Make sure the UUT has fresh batteries. See "Replacing the Batteries" earlier in this manual.

4. Warm up the calibrator and multimeter as required by their specifications.
5. Remove all input cables from the front of the UUT.
6. Make sure that the UUT is in a stable ambient temperature between 18 °C and 28 °C (64.4 °F and 82.4 °F) and that it has been warmed up for 5 minutes.

### Loop Power

1. Connect the UUT **SOURCE + (A $\overline{\sim}$ )** terminal to the **SIMULATE + ( $\overline{\sim}$ mA)** jack of the 789.
2. Connect the UUT **SOURCE - (mA $\overline{\sim}$ )** terminal to the **SIMULATE - (COM)** jack of the 787.
3. Enable the dc volts autorange function of the HP3458A multimeter.
4. Connect the voltage input terminals of the multimeter to the **SOURCE +** and **SOURCE -** terminals of the UUT as shown in Figure 2.
5. Select the **OUTPUT  $\overline{\sim}$ mA** rotary position of the 787 multimeter and turn the rotary knob of the UUT to **LOOP POWER** (the UUT provides loop power and acts as a current source).
6. Use the **% STEP** key on the 787 to simulate 24 mA.
7. Verify that the voltage read by the multimeter is greater than 30 V.
8. Push  $\bigcirc$ (BLUE) on the 789 to switch to its internal 250  $\Omega$ .
9. Verify that the voltage read by the multimeter is greater than 24 V.

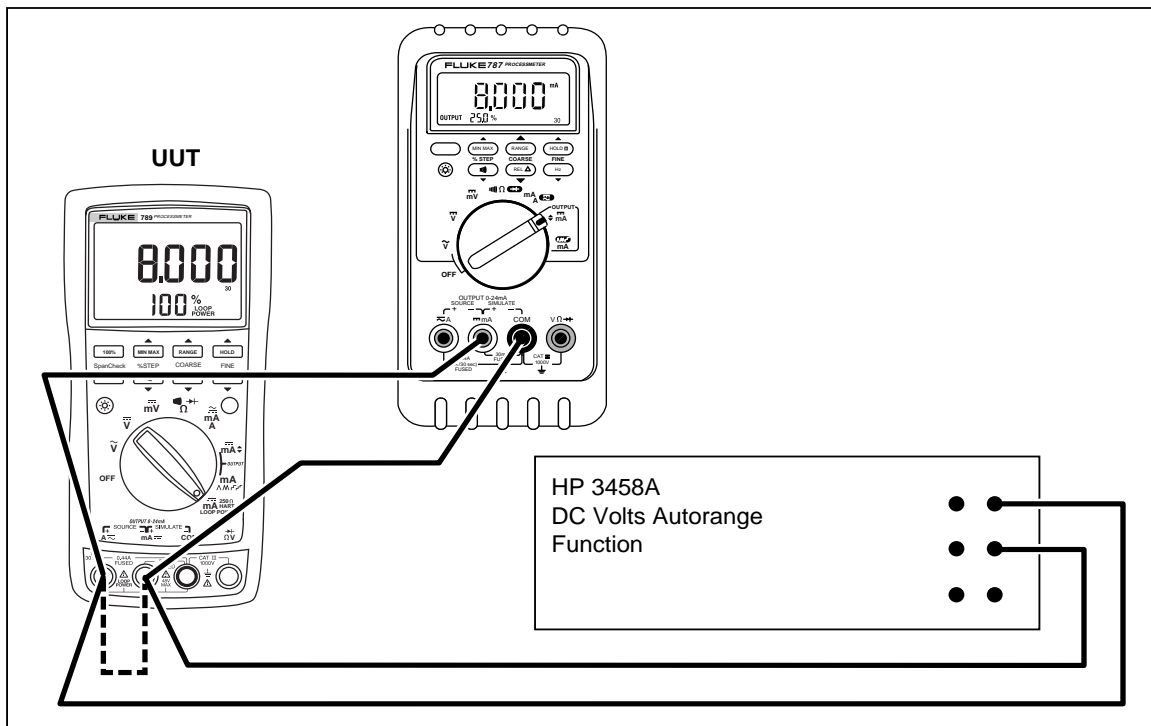

Figure 2. Verifying Loop Power

adm006F.EPS

### Current Sourcing

1. Put the calibrator in Standby (**STBY**) mode.
2. Connect the **SOURCE + (A $\sim$ )** and **- (mA $\overline{\sim}$ )** terminals on the UUT to the current terminals on the multimeter as shown in Figure 3.
3. Put the multimeter in the dc mA mode and manually select the 100 mA range. (Do not allow the multimeter to autorange.)
4. Turn the UUT rotary switch in the **OUTPUT mA $\overline{\sim}$**  position.
5. Use the **% STEP** and **COARSE** keys on the UUT to apply the values shown in Table 4 and compare the readings on the multimeter to the acceptable readings shown.

Table 4. Current Sourcing Test

| 787 Range          | 787 Output Current | Minimum Acceptable Multimeter Reading | Maximum Acceptable Multimeter Reading |
|--------------------|--------------------|---------------------------------------|---------------------------------------|
| No Range Switching | 4.000 mA           | 3.990 mA                              | 4.010 mA                              |
| No Range Switching | 12.000 mA          | 11.990 mA                             | 12.010 mA                             |
| No Range Switching | 20.000 mA          | 19.990 mA                             | 20.010 mA                             |

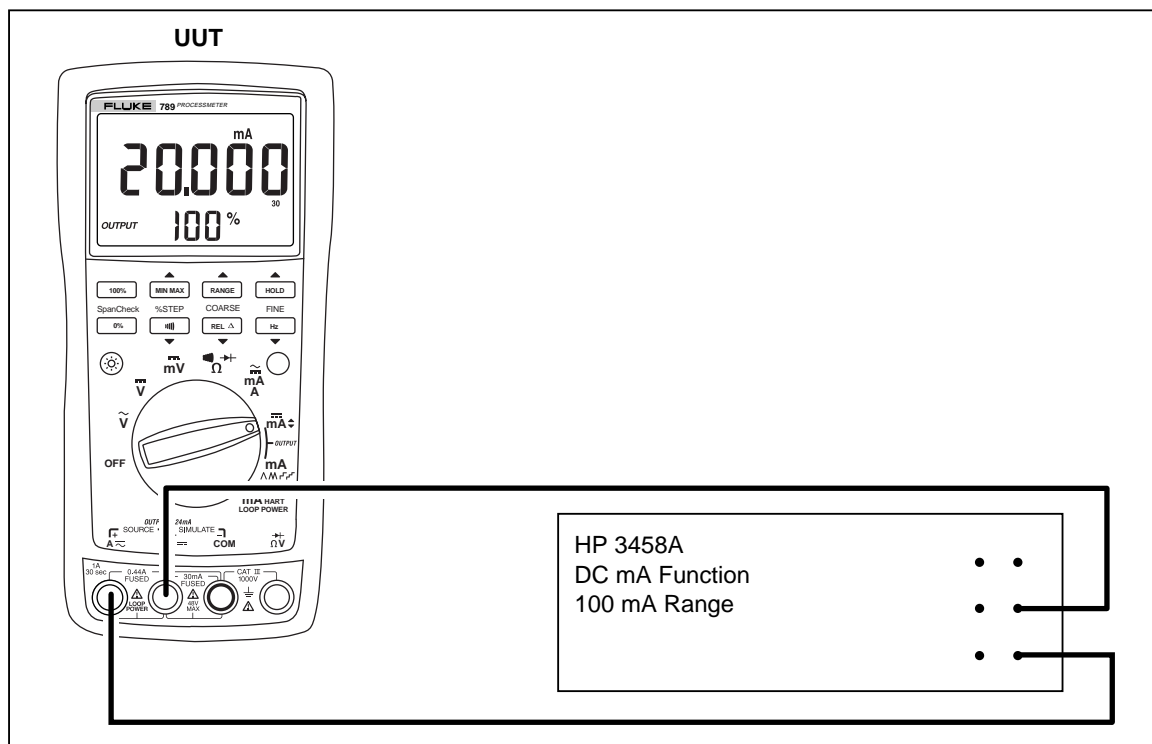

Figure 3. Current Sourcing Connections Using the HP 3458A

adm001F.EPS

### Current Measurement

1. Put the calibrator in Standby (**STBY**) mode.
2. Put the UUT rotary switch in the  $\overset{\sim}{\text{mA}}$  position.
3. Connect the calibrator to the **COM** and  $\overset{\sim}{\text{mA}}$  terminals on the UUT as shown in Figure 4.
4. Apply the values from the calibrator shown in Table 5 and compare the readings on the UUT to the acceptable readings shown.
5. Connect the calibrator to the **COM** and **A $\overset{\sim}$**  terminals on the UUT.
6. Apply the values from the calibrator shown in Table 5 and Table 6 and compare the readings on the UUT to the acceptable readings shown.
7. Press  $\bigcirc$ (BLUE) on the UUT to toggle to ac amps.
8. Apply the values from the calibrator shown in Table 7 and compare the readings on the UUT to the acceptable readings shown.

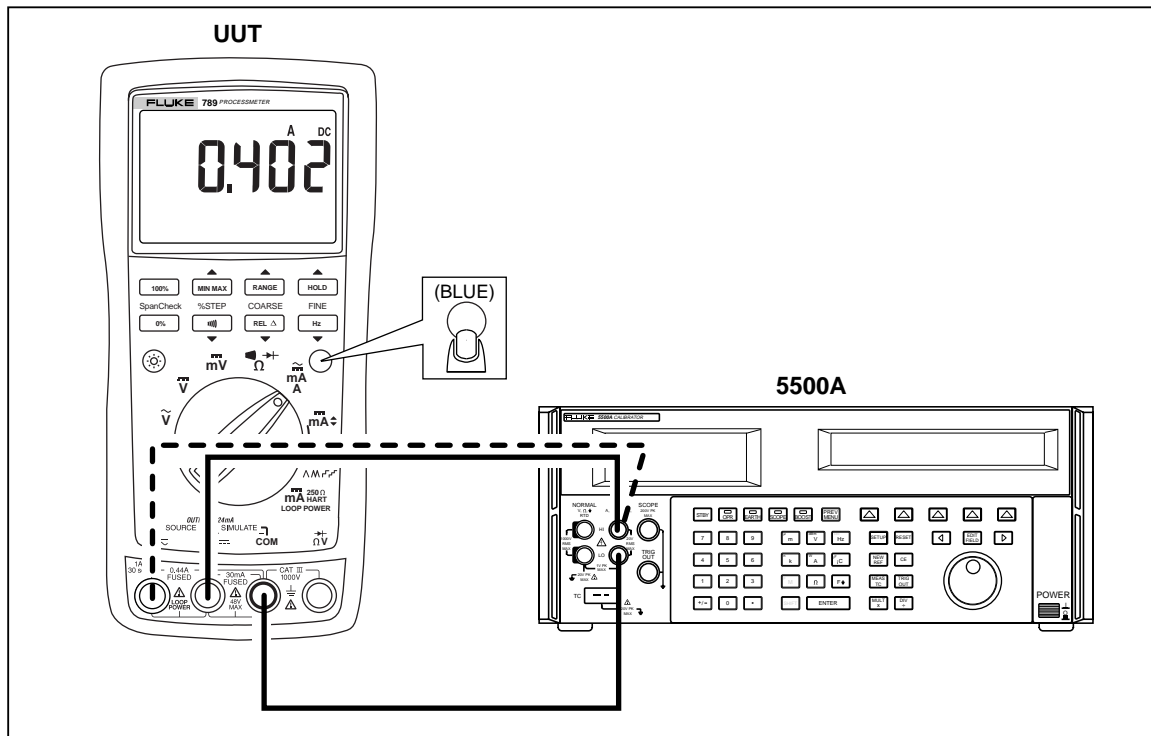

Figure 4. Current Measurement Test Connections

adm003F.EPS

**Table 5. DC mA Test**

| 789 Range          | Calibrator DC Current | Minimum Acceptable Reading | Maximum Acceptable Reading |
|--------------------|-----------------------|----------------------------|----------------------------|
| No Range Switching | 4.000 mA              | 3.996 mA                   | 4.004 mA                   |
| No Range Switching | 12.000 mA             | 11.992 mA                  | 12.008 mA                  |
| No Range Switching | 20.000 mA             | 19.988 mA                  | 20.012 mA                  |

**Table 6. DC Amp Test**

| 789 Range          | Calibrator DC Current | Minimum Acceptable Reading | Maximum Acceptable Reading |
|--------------------|-----------------------|----------------------------|----------------------------|
| No Range Switching | 0.100 A               | 0.098 A                    | 0.102 A                    |
| No Range Switching | 0.400 A               | 0.397 A                    | 0.403 A                    |

**Table 7. AC Amp Test**

| 789 Range          | Calibrator AC Current and Frequency | Minimum Acceptable Reading | Maximum Acceptable Reading |
|--------------------|-------------------------------------|----------------------------|----------------------------|
| No Range Switching | 0.100 A @ 60 Hz                     | 0.097 A                    | 0.103 A                    |
| No Range Switching | 0.400 A @ 60 Hz                     | 0.394 A                    | 0.406 A                    |

### Checking the Diode Test Function

1. Put the calibrator in Standby (**STBY**) mode.
2. Turn the UUT rotary switch in the  $\Omega \rightarrow +$  position.
3. Press  $\bigcirc$  (BLUE) to select diode test ( $\rightarrow +$ ).
4. Connect the calibrator to the **COM** and  $\Omega \rightarrow +$  terminals on the UUT as shown in Figure 5.
5. Apply 2.0 V dc from the calibrator.
6. The UUT should read between 1.959 V and 2.041 V.
7. Put the calibrator in Standby (**STBY**) mode; then disconnect the calibrator from the UUT.
8. Put the multimeter in the dc mA (autorange) function.
9. Connect the current terminals of the multimeter to the **COM** and  $\Omega \rightarrow +$  terminals on the UUT.
10. The multimeter should read close to 0.2 mA. (There is no tolerance specification for this current. This test just makes sure that the diode test current source is operating.)

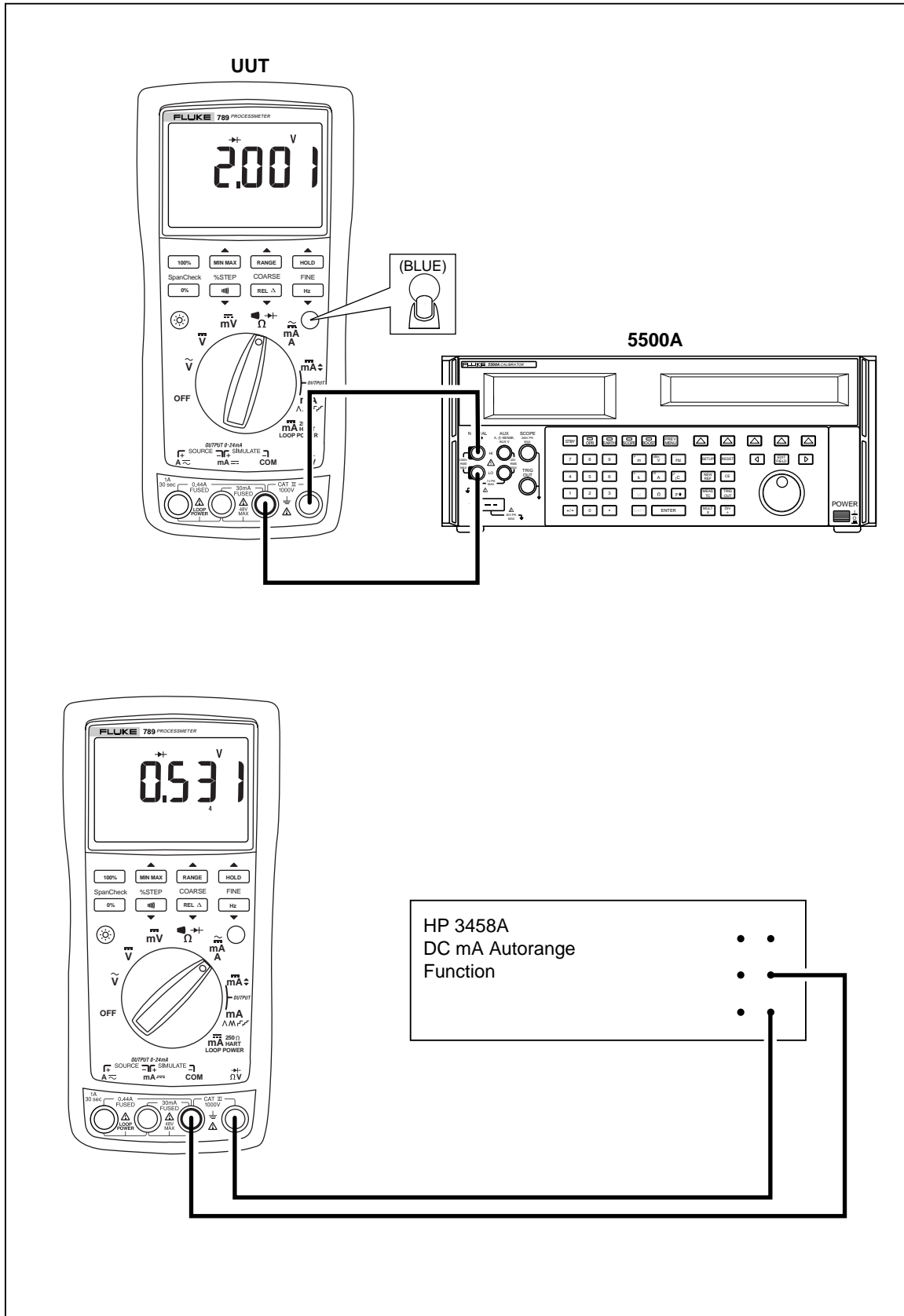



Figure 5. Diode Test Connections

adm007F.EPS



### Checking the Continuity Test Function

1. Put the calibrator in Standby (**STBY**) mode, and turn the UUT rotary switch to the  $\Omega$  position.
2. Connect the calibrator to the **COM** and  $\Omega$  terminals on the UUT as shown in Figure 6.
3. Press  (continuity beeper) on the UUT to select the continuity test.
4. Using the calibrator, apply a resistance output of  $230 \pm 20 \Omega$ . The beeper should stay off.
5. Using the calibrator, apply a resistance output of  $120 \pm 20 \Omega$ . The beeper should turn on.

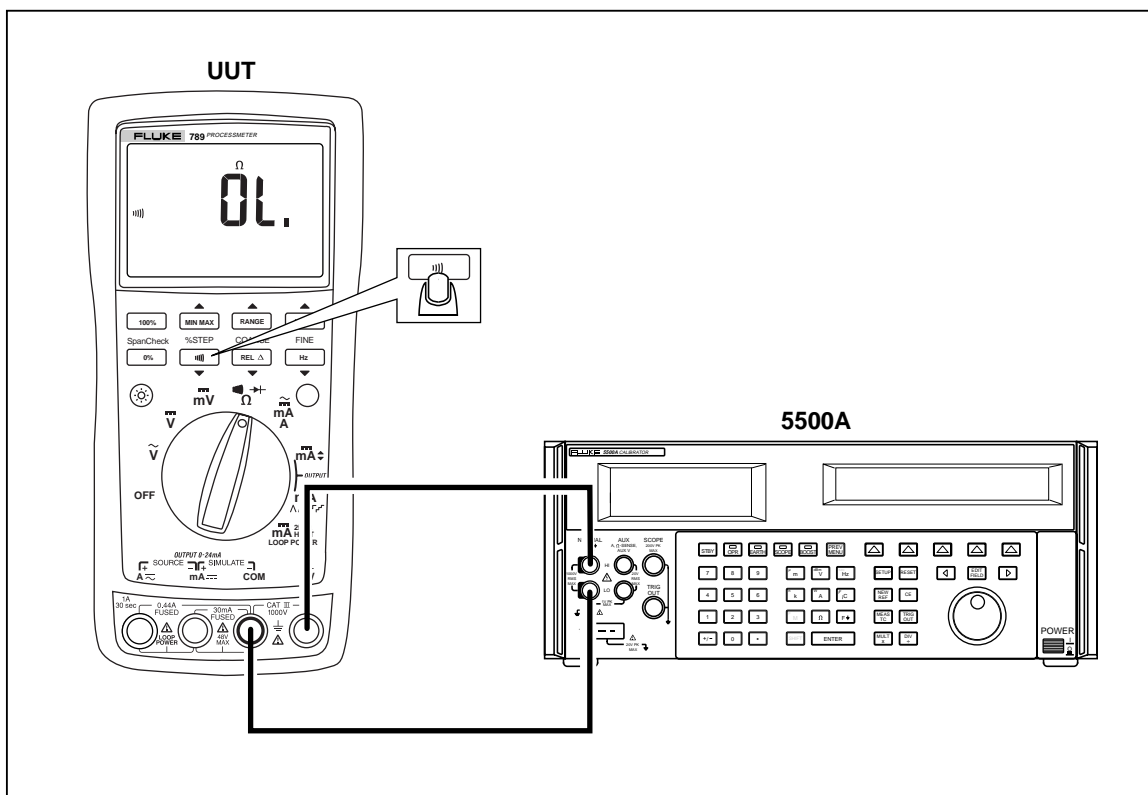

Figure 6. Continuity Test Connections

adm008F.EPS

### Resistance Measurement Test

1. Put the calibrator in Standby (**STBY**) mode.
2. Put the UUT rotary switch in the  $\Omega$  position.
3. Connect the **OUTPUT** and **SENSE** leads of the calibrator to the UUT as shown by the solid and dotted lines in Figure 7.
4. Apply the calibrator resistance values in Table 8 in the 789 400  $\Omega$  to 40 k $\Omega$  range. Compare the readings on the UUT to the acceptable readings shown.
5. Change the connections to the UUT. Using the Fluke 5440A-7002 low thermal leads, connect the calibrator to the UUT as shown by the solid lines in Figure 7.
6. Apply the rest of the calibrator resistance values in Table 8 (400 k $\Omega$  range and above). Compare the readings on the UUT to the acceptable readings shown.

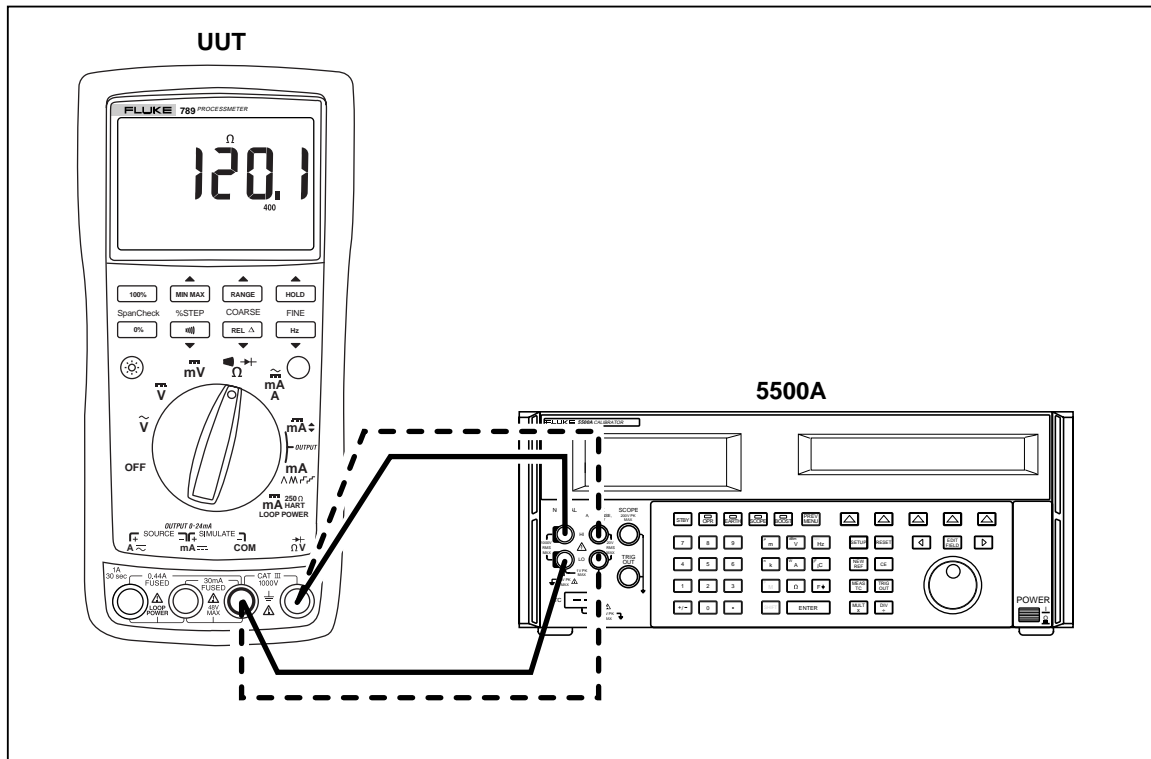

Figure 7. Resistance Measurement Test Connections

adm004F.EPS

**Table 8. Resistance Measurement Test Using a 5500A or 5520A Calibrator**

| <b>789 Range</b> | <b>Calibrator Resistance</b> | <b>Calibrator Compensation Mode</b> | <b>Minimum Reading</b> | <b>Maximum Reading</b> |
|------------------|------------------------------|-------------------------------------|------------------------|------------------------|
| 400 $\Omega$     | 120 $\Omega$                 | 2-Wire                              | 119.6 $\Omega$         | 120.4 $\Omega$         |
| 400 $\Omega$     | 300 $\Omega$                 | 2-Wire                              | 299.2 $\Omega$         | 300.8 $\Omega$         |
| 4 k $\Omega$     | 1.2 k $\Omega$               | 2-Wire                              | 1.197 k $\Omega$       | 1.203 k $\Omega$       |
| 4 k $\Omega$     | 3 k $\Omega$                 | 2-Wire                              | 2.993 k $\Omega$       | 3.007 k $\Omega$       |
| 40 k $\Omega$    | 12 k $\Omega$                | 2-Wire                              | 11.97 k $\Omega$       | 12.03 k $\Omega$       |
| 40 k $\Omega$    | 30 k $\Omega$                | 2-Wire                              | 29.93 k $\Omega$       | 30.07 k $\Omega$       |
| 400 k $\Omega$   | 120 k $\Omega$               | OFF                                 | 119.7 k $\Omega$       | 120.3 k $\Omega$       |
| 400 k $\Omega$   | 200 k $\Omega$               | OFF                                 | 199.5 k $\Omega$       | 200.5 k $\Omega$       |
| 400 k $\Omega$   | 300 k $\Omega$               | OFF                                 | 299.3 k $\Omega$       | 300.7 k $\Omega$       |
| 4 M $\Omega$     | 1.2 M $\Omega$               | OFF                                 | 1.993 M $\Omega$       | 1.207 M $\Omega$       |
| 4 M $\Omega$     | 3.0 M $\Omega$               | OFF                                 | 2.986 M $\Omega$       | 3.014 M $\Omega$       |
| 40 M $\Omega$    | 12 M $\Omega$                | OFF                                 | 11.67 M $\Omega$       | 12.33 M $\Omega$       |
| 40 M $\Omega$    | 30 M $\Omega$                | OFF                                 | 29.22 M $\Omega$       | 30.78 M $\Omega$       |

### DC Millivolts Measurement Test

1. Put the calibrator in Standby (**STBY**) mode.
2. Put the UUT rotary switch in the  $\overline{\text{mV}}$  position.
3. Connect the calibrator to the **COM** and  $\overline{\Omega^+V}$  terminals on the UUT as shown in Figure 8.
4. Apply the values from the calibrator shown in Table 9 and compare the readings on the UUT to the acceptable readings shown.

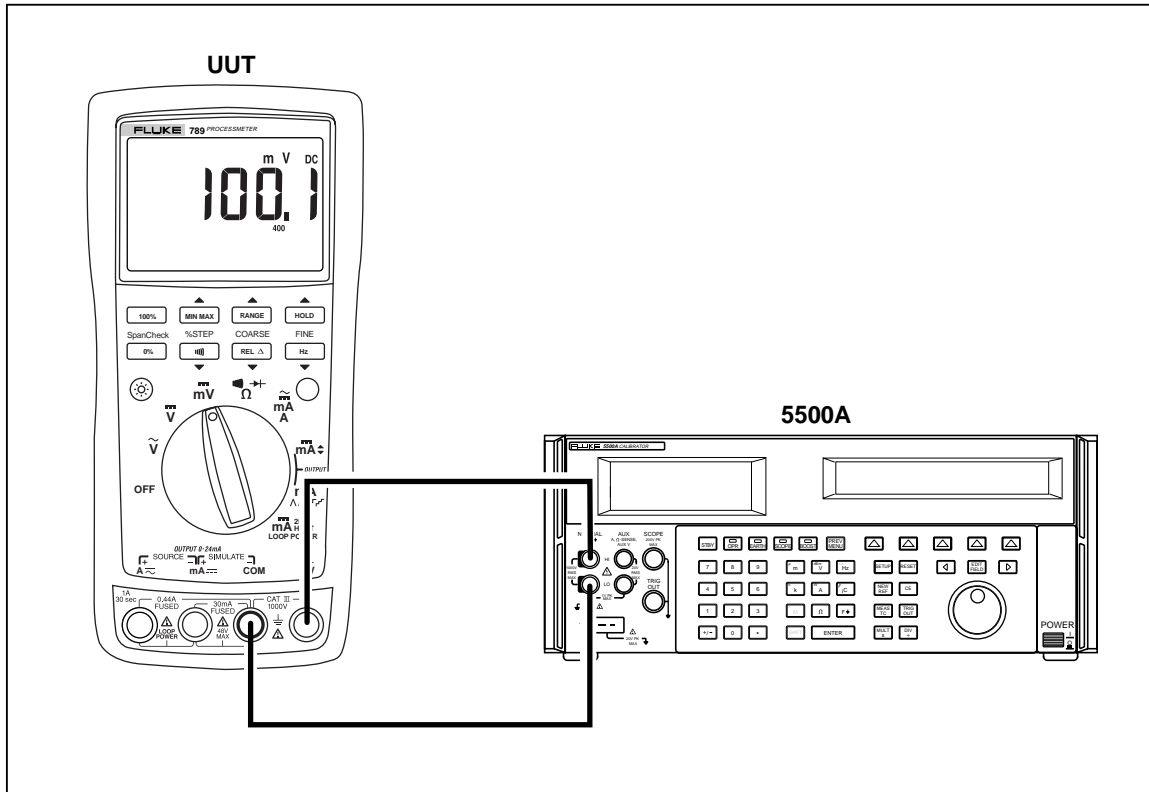

Figure 8. DC mV Measurement Test Connections

adm005F.EPS

Table 9. DC mV Test

| 789 Range          | Calibrator DC Voltage | Minimum Reading | Maximum Reading |
|--------------------|-----------------------|-----------------|-----------------|
| No Range Switching | 100 mV                | 99.8 mV         | 100.2 mV        |
| No Range Switching | 300 mV                | 299.6 mV        | 300.4 mV        |

## DC Volts Measurement Tests

### ⚠ ⚠ Warning

To avoid possible electrical shock or personal injury:

- Some of the calibration verification tests involve the use of high voltages and should be performed by qualified personnel only.
  - Always place the calibrator in the Standby (STBY) mode between tests and before handling the test connections or test cables.
1. Put the calibrator in Standby (STBY) mode.
  2. Put the UUT rotary switch in the  $\bar{V}$  position; select the autoranging mode.
  3. Connect the calibrator to the **COM** and  $\bar{V}$  terminals on the UUT as shown in Figure 9.
  4. Apply the values from the calibrator shown in Table 10 and compare the readings on the UUT to the acceptable readings shown.

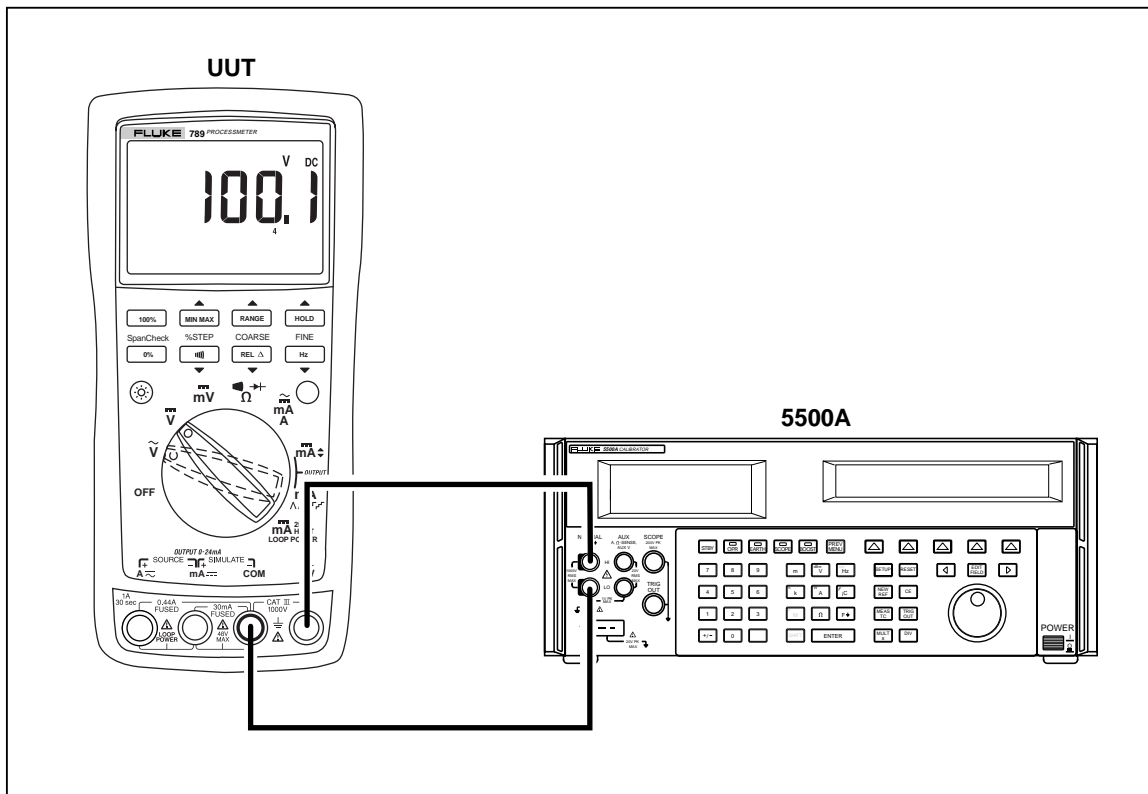

Figure 9. AC/DC Voltage Measurement Test Connections

adm009F.EPS

Table 10. DC Volts Test

| 789 Range | Calibrator DC Voltage | Minimum Reading | Maximum Reading |
|-----------|-----------------------|-----------------|-----------------|
| 4 V dc    | 1 V                   | 0.998 V         | 1.002 V         |
| 4 V dc    | 3 V                   | 2.996 V         | 3.004 V         |
| 40 V dc   | 10 V                  | 9.98 V          | 10.02 V         |
| 40 V dc   | 30 V                  | 29.96 V         | 30.04 V         |
| 400 V dc  | 100 V                 | 99.8 V          | 100.2 V         |
| 400 V dc  | 300 V                 | 299.6 V         | 300.4 V         |
| 1000 V dc | 100 V                 | 99              | 101             |
| 1000 V dc | 800 V                 | 798             | 802             |

**AC Volts Measurement Test****⚠ ⚠ Warning**

To avoid possible electrical shock or personal injury:

- Some of the calibration verification tests involve the use of high voltages and should be performed by qualified personnel only.
  - Always place the calibrator in the Standby (STBY) mode between tests and before handling the test connections or test cables.
1. Put the calibrator in Standby (**STBY**) mode.
  2. Put the UUT rotary switch in the  $\tilde{V}$  position.
  3. Connect the calibrator to the **COM** and  $\Omega V^+$  terminals on the UUT as shown in Figure 9.
  4. Apply the values from the calibrator shown in Table 11 and compare the readings on the UUT to the acceptable readings shown.

Table 11. AC Volts Test

| 789 Range | Calibrator Voltage and Frequency | Minimum Acceptable Reading | Maximum Acceptable Reading |
|-----------|----------------------------------|----------------------------|----------------------------|
| 400 mV ac | 100 mV @ 60 Hz                   | 98.9 mV                    | 101.1 mV                   |
| 400 mV ac | 300 mV @ 60 Hz                   | 297.5 mV                   | 302.5 mV                   |
| 4 V ac    | 1 V @ 60 Hz                      | 0.991 V                    | 1.009 V                    |
| 4 V ac    | 2 V @ 60 Hz                      | 1.984 V                    | 2.016 V                    |
| 4 V ac    | 3 V @ 60 Hz                      | 2.977 V                    | 3.023 V                    |
| 40 V ac   | 10 V @ 60 Hz                     | 9.91 V                     | 10.09 V                    |
| 40 V ac   | 30 V @ 60 Hz                     | 29.77 V                    | 30.23 V                    |
| 400 V ac  | 100 V @ 60 Hz                    | 99.1 V                     | 100.9 V                    |
| 400 V ac  | 300 V @ 60 Hz                    | 297.7 V                    | 302.3 V                    |
| 1000 V ac | 100 V @ 60 Hz                    | 97                         | 103                        |
| 1000 V ac | 800 V @ 60 Hz                    | 792                        | 808                        |

### Frequency Measurement Test

1. Put the calibrator in Standby (**STBY**) mode.
2. Put the UUT rotary switch in the  $\tilde{V}$  (ac volts) position.
3. Press  $\boxed{\text{Hz}}$  to toggle to the frequency measurement function.
4. Connect the calibrator to the **COM** and  $\Omega V$  terminals on the UUT as shown in Figure 10.
5. Apply the values from the calibrator shown in Table 12 and compare the readings on the UUT to the acceptable readings shown.

Table 12. Frequency Measurement Test

| 789 Range  | Calibrator Voltage and Frequency | Minimum Acceptable Reading | Maximum Acceptable Reading |
|------------|----------------------------------|----------------------------|----------------------------|
| 199.99 Hz  | 5 V @ 100 Hz                     | 99.98 Hz                   | 100.02 Hz                  |
| 1999.9 Hz  | 5 V @ 1000 Hz                    | 999.8 Hz                   | 1000.2 Hz                  |
| 19.999 kHz | 5 V @ 10 kHz                     | 9.998 kHz                  | 10.002 kHz                 |

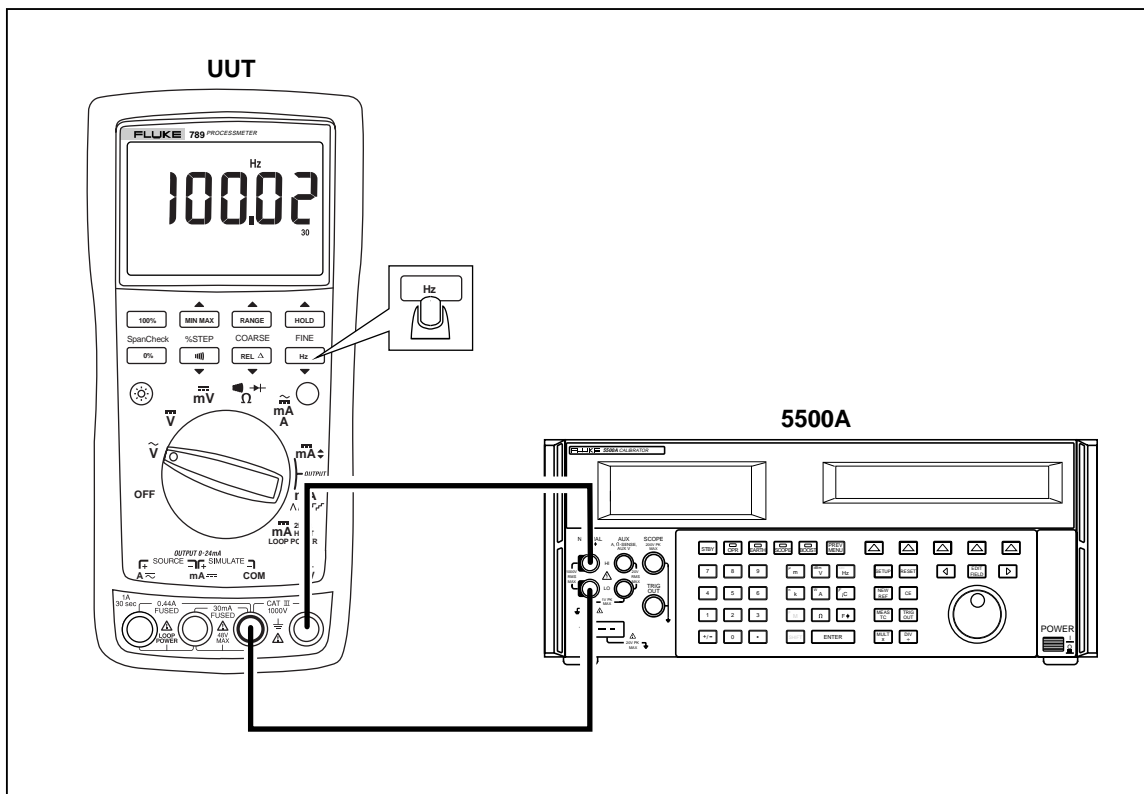

Figure 10. Frequency Measurement Test Connections

adm010F.EPS

## Calibration Adjustment

The Processmeter is calibrated using a closed-case procedure.

Calibrate the ProcessMeter once a year to ensure that it performs according to its specifications.

### Preparing for Calibration Adjustment

#### **⚠ ⚠ Warning**

To avoid possible electric shock or personal injury:

- Do not use the ProcessMeter if it looks damaged.
- Inspect the ProcessMeter for damage, especially around the input terminals. Inspect the test leads and test connections for damaged insulation or exposed metal.
- Look for cracks, missing plastic or damaged insulation. If damage is detected, do not continue; contact Fluke to have the ProcessMeter serviced.
- Make sure that the battery compartment door on the ProcessMeter is closed and latched before using it.
- Check the test leads for continuity. Replace damaged test leads as necessary.
- Do not use the ProcessMeter if it appears to operate abnormally. Protection designed into the ProcessMeter might be impaired. If in doubt, have the ProcessMeter serviced.
- To avoid electrical shock, always place the calibrator in the Standby (STBY) mode between tests and before handling the test connections or test cables.
- Some of the calibration adjustment procedures involve the use of high voltages and should be performed by qualified personnel only.



*Note*

*The calibration adjustment procedures assume that the person performing them knows how to use the ProcessMeter and the required equipment. Do not attempt to calibrate the ProcessMeter unless you are qualified to do so.*

*Throughout the following, “UUT” (unit under test) refers to the ProcessMeter; the word “multimeter” is reserved for the digital multimeter identified in the required equipment listed in Table 2.*

*Calibration adjustment should be performed in an RF field < 1 V/m such as a laboratory environment.*

To prepare for calibration adjustment, do the following:

1. Make sure that you have the required equipment available (see Table 2 ).
2. Make sure that both fuses in the UUT are intact. See “Checking and Replacing the Fuses” earlier in this manual.
3. Turn on and warm up the calibrator as required by its specifications.
4. Remove all input cables from the front of the UUT.
5. Make sure that the UUT is in an ambient temperature between 18 °C and 28 °C (64.4 °F and 82.4 °F).

### **AC Voltage Adjustment**

1. Connect the Processmeter to the volt/ohm output of the 5500A calibrator.
2. Turn the UUT’s switch to  $\tilde{V}$ .
3. The calibration button is located on the backside of the Processmeter, under the Calibration Seal. Use a small probe to break the seal.
4. Press and hold the Calibration Button for approximately 2 seconds. The unit will beep (see Figure 11).

*Note*

*Pressing the Calibration Button puts the Processmeter into and out of calibration mode. The Processmeter will remain in calibration mode until the unit is turned off or the calibration button is pressed a second time.*

**CAL** appears in the bottom display when the Processmeter is in calibration mode.

5. Apply the voltages listed below as prompted by the Processmeter.
6. Press  after each sourced value appears. Do not alter the sourced value while the display reads **Busy**.

Applied voltages:

- 4 mV @ 60 Hz
  - 40 mV @ 60 Hz
  - 400 mV @ 60 Hz
  - 4 V @ 60 Hz
  - 40 V @ 60 Hz
  - 400 V @ 60 Hz
  - 1000 V @ 60 Hz
7. When **Store** is displayed, press  to store the calibration value.

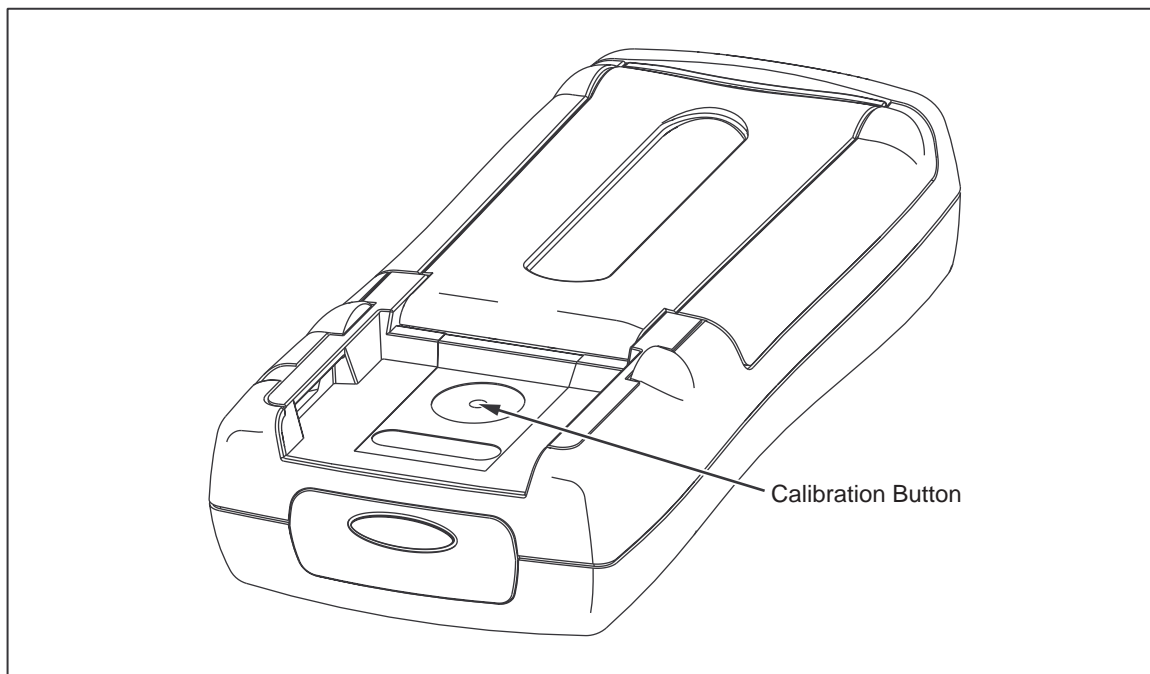

Figure 11. Calibration Button Access

aa04f.eps

### Frequency Adjustment

1. Connect the Processmeter to the volt/ohm output of the 5500A calibrator.
2. Turn the UUT's switch to  $\tilde{V}$ .
3. Push .
4. Press and hold the Calibration Button for approximately 2 seconds. The unit will beep (see Figure 11).

#### Note

*Pressing the Calibration Button puts the Processmeter into and out of calibration mode. The Processmeter will remain in calibration mode until the unit is turned off or the calibration button is pressed a second time.*

**CAL** appears in the bottom display when the Processmeter is in calibration mode.

5. Apply 4 V @ 5000 Hz.
6. Press  after the sourced value appears. Do not alter the sourced value while the display reads **Busy**.
7. When **Store** is displayed, press  to store the calibration value.

### DC Voltage Adjustment

1. Connect the Processmeter to the volt/ohm output of the 5500A calibrator.
2. Turn the UUT's switch to  $\overline{V}$ .
3. Press and hold the Calibration Button for approximately 2 seconds. The unit will beep (see Figure 11).

#### Note

*Pressing the Calibration Button puts the Processmeter into and out of calibration mode. The Processmeter will remain in calibration mode until the unit is turned off or the calibration button is pressed a second time.*

**CAL** appears in the bottom display when the Processmeter is in calibration mode.

4. Press  after each sourced value appears. Do not alter the sourced value while the display reads **Busy**.

Applied voltages:

- 0 V
- 4 V
- 40 V
- 400 V
- 1000 V

5. When **Store** is displayed, press  to store the calibration value.

### DC Millivolts Adjustment

1. Connect the Processmeter to the volt/ohm output of the 5500A calibrator.
2. Turn the UUT's switch to  $\overline{\text{mV}}$ .
4. Press and hold the Calibration Button for approximately 2 seconds. The unit will beep (see Figure 11).

#### Note

*Pressing the Calibration Button puts the Processmeter into and out of calibration mode. The Processmeter will remain in calibration mode until the unit is turned off or the calibration button is pressed a second time.*

**CAL** appears in the bottom display when the Processmeter is in calibration mode.

3. Apply 0 V. Press  after the sourced value appears. Do not alter the sourced value while the display reads **Busy**.
4. Apply 400 mV. Press  after the sourced value appears. Do not alter the sourced value while the display reads **Busy**.
5. When **Store** is displayed, press  to store the calibration value.

### Ohms Adjustment

1. Connect the Processmeter to the volt/ohm output of the 5500A calibrator.
2. Turn the UUT's switch to  $\overline{\Omega}$ .
3. Press and hold the Calibration Button for approximately 2 seconds. The unit will beep (see Figure 11).

#### Note

*Pressing the Calibration Button puts the Processmeter into and out of calibration mode. The Processmeter will remain in calibration mode until the unit is turned off or the calibration button is pressed a second time.*

**CAL** appears in the bottom display when the Processmeter is in calibration mode.

4. Apply the resistances listed below. Press  after each sourced value appears. Do not alter the sourced value while the display reads **Busy**.

Applied resistances:

- 0  $\Omega$
- 400  $\Omega$
- 4 k $\Omega$
- 40 k $\Omega$
- 400 k $\Omega$
- 4 M $\Omega$
- 40 M $\Omega$

5. When **Store** is displayed, press  to store the calibration value.

### Diode Adjustment

1. Connect the Processmeter to the volt/ohm output of the 5500A calibrator.
2. Turn the UUT's switch to  $\Omega \rightarrow$ .
3. Press  $\bigcirc$  (blue) to enter the diode function.
4. Press and hold the Calibration Button for approximately 2 seconds. The unit will beep (see Figure 11).

#### Note

*Pressing the Calibration Button puts the Processmeter into and out of calibration mode. The Processmeter will remain in calibration mode until the unit is turned off or the calibration button is pressed a second time.*

**CAL** appears in the bottom display when the Processmeter is in calibration mode.

*Before applying 0 V dc, the 5500 must be range locked in the 3.3 V range. Impedance of 330 mV range changes the 0 V point.*

5. Apply 0 V dc. Press  after the sourced value appears. Do not alter the sourced value while the display reads **Busy**.
6. Apply 1 V dc. Press  after the sourced value appears. Do not alter the sourced value while the display reads **Busy**.
7. When **Store** is displayed, press  to store the calibration value.

### Milliamps DC Adjustment

1. Connect the Processmeter to the mA output of the 5500A calibrator.
2. Turn the UUT's switch to  $\overset{\approx}{\text{mA}}$ . Make sure the test leads are in the **mA** and **COM** inputs.
3. Press and hold the Calibration Button for approximately 2 seconds. The unit will beep (see Figure 11).

#### Note

*Pressing the Calibration Button puts the Processmeter into and out of calibration mode. The Processmeter will remain in calibration mode until the unit is turned off or the calibration button is pressed a second time.*

**CAL** appears in the bottom display when the Processmeter is in calibration mode.

4. Apply 0 mA dc. Press  after the sourced value appears. Do not alter the sourced value while the display reads **Busy**.
5. Apply 30 mA dc. Press  after the sourced value appears. Do not alter the sourced value while the display reads **Busy**.
6. When **Store** is displayed, press  to store the calibration value.

### Amps DC Adjustment

1. Connect the Processmeter to the A output of the 5500A calibrator.
2. Turn the UUT's switch to  $\frac{\text{m}\ddot{\text{A}}}{\text{A}}$ . Make sure the test leads are in the **A** and **COM** jacks.
3. Press and hold the Calibration Button for 2 seconds (see Figure 11). The unit will beep.
4. Apply 0 A dc. Press  after the reading stabilizes.
5. Apply 1 A dc. Press  after the reading stabilizes.

#### **⚠ Caution**

**Remove 1 A from UUT promptly after storing calibration constant.  
Fuse will blow after 30 seconds.**

6. Store calibration constants by pressing .

### Amps AC Adjustment

1. Connect the Processmeter to the A output of the 5500A calibrator.
2. Turn the UUT's switch to  $\frac{\text{m}\ddot{\text{A}}}{\text{A}}$ .
3. Press  (blue) to enter the A ac function.
4. Press and hold the Calibration Button for 2 seconds (see Figure 11). The unit will beep.
5. Apply 0.05 A ac @ 60 Hz. Press  after the reading stabilizes.
6. Apply 1 A ac. Press  after the reading stabilizes.
7. Store calibration constants by pressing .

#### **⚠ Caution**

**Remove 1 A from UUT promptly after storing calibration constant.  
Fuse will blow after 30 seconds.**

### Milliamps Output Adjustment

1. Connect the Processmeter A output to the 3458 input.
2. UUT will output approximately 4 mA. Use the fine and coarse adjustments on the UUT to get a 4.000 mA reading on the 3458.
3. Press  after 4.000 mA reading is reached on the 3458.
4. UUT will output approximately 20 mA. Use the fine and coarse adjustments on the UUT to get a 20.000 on the 3458.
5. Press  after 20.000 mA reading is reached on the 3458.
6. Store calibration constants by pressing .

## Replacement Parts and Accessories

### ⚠ ⚠ Warning

To avoid personal injury or damage to the ProcessMeter, use only the specified replacement fuse, 440 mA 1000 V fast-blow, Fluke PN 943121.

### Note

When servicing the ProcessMeter, use only the replacement parts specified here.

Replacement parts and some accessories are shown in Figure 12 and listed in Table 13. Many more DMM accessories are available from Fluke. For a catalog, contact the nearest Fluke distributor.

To find out how to order parts or accessories use the telephone numbers or addresses shown in "Contacting Fluke".

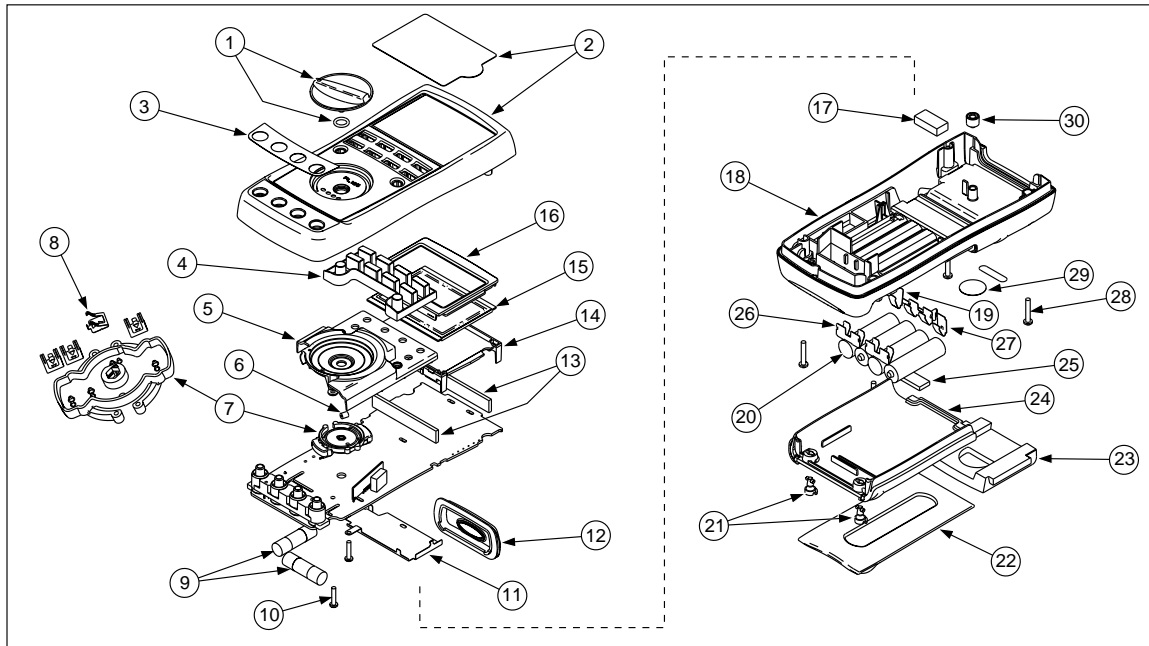

Figure 12. Replacement Parts

anw005f.eps

Table 13. Replacement Parts

| Item Number | Reference Designator | Description                          | Fluke PN or Model no. | Quantity     |
|-------------|----------------------|--------------------------------------|-----------------------|--------------|
| ①           | MP14                 | Knob Assembly                        | 658440                | 1            |
| ②           | MP1                  | Top Case with Lens Protector         | 1622862               | 1            |
| ③           | MP8                  | Decal, Top Case                      | 1623923               | 1            |
| ④           | MP6                  | Keypad                               | 1622951               | 1            |
| ⑤           | MP5                  | Top Shield                           | 1622924               | 1            |
| ⑥           | MP47                 | Top Shield Contact                   | 674853                | 1            |
| ⑦           | MP4                  | Contact Housing                      | 1622913               | 1            |
| ⑧           | MP28-31              | RSOB Contact                         | 1567683               | 4            |
| ⑨           | △ F1, F2             | Fuse, 440 mA, 1000 V fast-blow       | 943121                | 2            |
| ⑩           | H7,8                 | PCB Screw                            | 832220                | 2            |
| ⑪           | MP9                  | Bottom Shield                        | 1675171               | 1            |
| ⑫           | MP12                 | IR Lens                              | 658697                | 1            |
| ⑬           | MP40,41              | LCD Connectors, Elastomeric          | 1641965               | 2            |
| ⑭           | MP7                  | Backlight/Bracket                    | 1622960               | 1            |
| ⑮           | P1                   | LCD Display                          | 1883431               | 1            |
| ⑯           | MP3                  | Mask                                 | 1622896               | 1            |
| ⑰           | MP50                 | Shock Absorber                       | 878983                | 1            |
| ⑱           | MP11                 | Bottom Case                          | 659042                | 1            |
| ⑲           | MP20                 | Battery Contact, Negative            | 658382                | 1            |
| ⑳           | BT1-4                | Battery, 1.5 V, 0-15 mA, AA Alkaline | 376756                | 4            |
| ㉑           | H1-2                 | Fasteners, Battery/Fuse Access Door  | 948609                | 2            |
| ㉒           | MP13                 | Tilt-Stand                           | 659026                | 1            |
| ㉓           | MP15                 | Accessory Mount with Probe Holders   | 658424                | 1            |
| ㉔           | MP2                  | Access Door, Battery/Fuse            | 1622870               | 1            |
| ㉕           | MP46                 | Shock Absorber                       | 674850                | 1            |
| ㉖           | MP16-18              | Battery Contacts Dual                | 666435                | 3            |
| ㉗           | MP19                 | Battery Contact, Positive            | 666438                | 1            |
| ㉘           | H3-6                 | Case Screws                          | 1558745               | 4            |
| ㉙           | MP21                 | Calibration Label                    | 948674                | 1            |
| ㉚           | MP22                 | Calibration Keypad                   | 658689                | 1            |
| -           | Not shown            | TL71 Test Leads                      | 1274382               | 1 (set of 2) |
| -           | Not shown            | AC72 Alligator Clips                 | 1670095               | 1 (set of 2) |
| -           | Not shown            | 789 Product Overview                 | 1627890               | 1            |
| -           | Not shown            | CD-ROM (Contains Users Manual)       | 1636493               | 1            |